



# VE-1x/2x Series Velocity Sensor

## Installation and Operation Manual

Company:	<b>GeoSIG Ltd</b> Wiesenstrasse 39, 8952 Schlieren, Switzerland, Tel: +41 44 810 21 50, Fax: +41 44 810 23 50, E-mail: info@geosig.com
Author:	Ralph Böniger
Checked:	Dr. Talhan Biro
Approved:	Johannes Grob
Distribution:	GeoSIG Ltd, Customer on request

## Document Revision

<b>Version</b>	<b>Action</b>
21.09.1995	First issue
21.01.1997	One document for all the GSV types
29.10.2001	Update technical issues
13.05.2003	Change model number to GSV types
24.09.2003	Update technical issues
17.02.2005	Updated naming for 1x and 2x only, TB
12.06.2014	New Logo and updated address
05.05.2015	Correction of description

### Disclaimer

GeoSIG Ltd reserves the right to change the information contained in this document without notice. While the information contained herein is assumed to be accurate, GeoSIG Ltd assumes no responsibility for any errors or omissions.

### Copyright Notice

No part of this document may be reproduced without the prior written consent of GeoSIG Ltd. The software described in this document is furnished under license and may only be used or copied in accordance with the terms of such a license.

### Trademark

All brand and product names mentioned are trademarks or registered trademarks of their respective holders.

All rights reserved  
GeoSIG Ltd  
Switzerland

# Table of Contents

- 1. INTRODUCTION ..... 4**
- 2. INSTALLATION ..... 4**
  - 2.1. INSTALLING ..... 4**
    - 2.1.1. Verifying Installation ..... 5
  - 2.2. ELECTRICAL CONNECTION ..... 5**
    - 2.2.1. Connector Pin Assignment ..... 5
    - 2.2.2. Connecting to a Recorder ..... 7
    - 2.2.3. Cable Configuration, Specification and Length ..... 7
- 3. OPERATION AND CONFIGURATION ..... 8**
  - 3.1. AXIS ORIENTATION CONFIGURATION ..... 8**
  - 3.2. SCALE FACTOR / GAIN ..... 8**
  - 3.3. SELF TEST ..... 8**
  - 3.4. OPERATION CONFIRMATION ..... 9**
- 4. SPECIFICATIONS ..... 9**
- 5. MAINTENANCE ..... 9**
- 6. THEORY OF OPERATION ..... 9**

## 1. Introduction

The GeoSIG VE-1x/2x series velocity sensors consist of the following sensor types:

Frequency response 1 Hz to 315 Hz:

- VE-11 uniaxial
- VE-12 biaxial
- VE-13 triaxial

Frequency response 4.5 Hz to 315 Hz:

- VE-21 uniaxial
- VE-22 biaxial
- VE-23 triaxial

All sensor types are implemented in the same waterproof, 94 x 96 x 193 mm cast aluminium housing. The modules inside the VE velocity sensors are 1 to 3 high quality geophones, geophone signal amplifier, gain ranger, geophone integrator (VE-1x only) and current loop interface for 0 to 20 mA output. Since the modules can easily be added regarding specific user requirements, the VE velocity sensors offer maximum versatility in obtaining the desired performance.

Small size and single bolt fixation allows for both saving space and installation time. Levelling is accomplished via three point levelling screws. Alternatively, the flanges that support levelling can be used for mounting if desired.

## 2. Installation

The VE velocity sensors are fairly simple devices to use, but some care must be taken in installation to be assured of proper performance. Because there are many considerations, we recommend that before starting installation, you review each section of this manual to ensure the best possible chance of a simple installation that works right the first time. Prior to and after installation we recommend that you verify functionality of the VE velocity sensor and the cable assembly with testing the output signal and test pulse response of the sensor. This may save time and trouble as well as give confidence that connections are done correctly.

The location of the sensor, preferably as close as possible to the associated recorder, should be as level and smooth as possible and the foundation should be of concrete, rock or similar material which is perfectly bonded to the ground or structure to be measured or monitored. Special installations such as installing vertically on a reinforced concrete wall (i.e. vertical foundation) are also possible, provided that the sensor is compatible with the required orientation, the location is appropriately selected and the sensor is properly mounted.

### 2.1. Installing

The VE velocity sensor must be firmly mounted to the foundation and levelled using the single centre pivot bolt and the three point levelling screws as shown in Figure 1. The "T" slot on the bottom of the sensor housing is made to accept an M8 x 35 mm stainless steel bolt head. This centre pivot bolt is first fastened to the foundation leaving approximately 18 – 20 mm of height above the installation surface. The sensor, at its "T" slot, is then slipped onto the bolt head and oriented in the proper direction. The three point levelling screws are then adjusted and tightened to both level the sensor and securely fasten it to the surface.

 *In order to prevent any damage to the sensor housing or the fixation screw and/or anchor, do not tighten the levelling screws using excessive force.*

Use a bubble level and place it on the top of sensor surface, level first along one axis, then the other as final levelling adjustments are made.

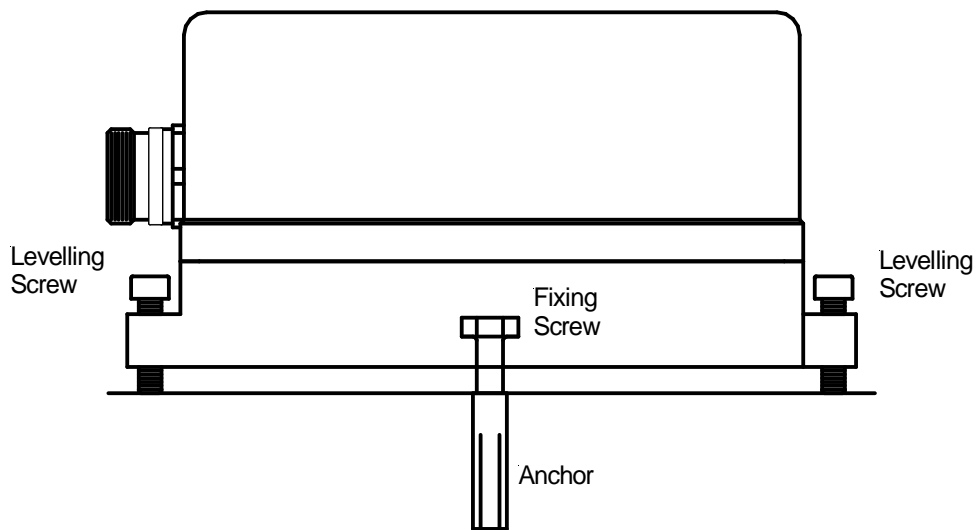

Figure 1. Mounting the VE Velocity Sensor

### 2.1.1. Verifying Installation

Check to be sure that the sensor is aligned to produce the desired output signals as follows:

- For any axis or any combination of axes, a movement in the axis (or combination) direction indicated on the label of the sensor housing should produce a positive output signal, which can be observed on the output of the sensor (via the associated recorder).

Note that the standard orientations of the axes are in accordance with the right hand rule:

- positive x-axis is in the direction of the thumb,
- positive y-axis is in the direction of the pointer finger
- positive z-axis in the direction of the middle finger of the right hand.

Make sure that your sensor is oriented properly for your requirements.

 Please contact GeoSIG if you wish to change any axis direction / orientation.

 You might as well utilize your sensor by not fixing it to the foundation (in the case of horizontal foundations) but rather by placing it on the foundation, taking measurements and relocating for temporary or mobile measurements. However, according to DIN 45669-1, velocity sensors must be fixed to the ground as soon as the vibrations measured are higher than 1/3 of gravitational acceleration ( $> 3.27 g$ ).

## 2.2. Electrical Connection

### 2.2.1. Connector Pin Assignment

The VE velocity sensors may be equipped with different connection versions:

- with 2 m cable and no connector
- with 2 m cable and a 12 pin male connector
- with a 12 pin male housing plug
- (open frame) with direct PCB connection

The connections and pin assignment are shown in **Table 1** through **Table 3**. All connectors use the same 12 pin connector. Following connectors are used in the VE velocity sensors:

- Sensor housing plug, 12-pin male
- Sensor cable connector (to connect VE to GSR), 12-pin male
- Extension cable connector (to connect to VE cable connector), 12-pin female

**Table 1. VE Internal PCB Pin Assignment**

12 Pin	Name	12 Lead Cable Colour	Description
1	Sens_X_HI	white	X-Signal high
2	Sens_X_LO	brown	X-Signal low
3	Sens_Y_HI	green	Y-Signal high
4	Sens_Y_LO	yellow	Y-Signal low
5	Sens_Z_HI	grey	Z-Signal high
6	Sens_Z_LO	pink	Z-Signal low
7	S_Test	blue	Sensor Test Signal
8	AGND	red	Analog Ground
9	V_EXT	black	External Voltage (12VDC)
10	AGND	violet	Analog Ground
11	S_MODE	grey-pink	Sensor Mode Signal
12	AGND	red-blue	Analog Ground

**Table 2. VE Sensor Housing Pin Assignment**

12 Pin	Name	12 Lead Cable Colour	Description
1	Sens_X_HI	white	X-Signal high
2	Sens_X_LO	brown	X-Signal low
3	Sens_Y_HI	green	Y-Signal high
4	Sens_Y_LO	yellow	Y-Signal low
5	Sens_Z_HI	grey	Z-Signal high
6	Sens_Z_LO	pink	Z-Signal low
7	S_Test	blue	Sensor Test Signal
8	AGND	red	Analog Ground
9	V_EXT	black	External Voltage (12VDC)
10	AGND	violet	Analog Ground
11	S_MODE	grey-pink	Sensor Mode Signal
12	AGND	red-blue	Analog Ground

**Table 3. VE Sensor Cable Pin Assignment**

12 Pin	Name	12 Lead Cable Colour	Description
1	Sens_X_HI	white	X-Signal high
2	Sens_X_LO	brown	X-Signal low
3	Sens_Y_HI	green	Y-Signal high
4	Sens_Y_LO	yellow	Y-Signal low
5	Sens_Z_HI	grey	Z-Signal high
6	Sens_Z_LO	pink	Z-Signal low
7	S_Test	blue	Sensor Test Signal
8	AGND	red	Analog Ground
9	V_EXT	black	External Voltage (12VDC)
10	AGND	violet	Analog Ground
11	S_MODE	grey-pink	Sensor Mode Signal
12	AGND	red-blue	Analog Ground

The VE velocity sensor operates from a single unregulated supply voltage of 12 VDC (10 to 15 VDC). The analog output voltages are referenced to 2.5 VDC. Analog Reference Voltage available internally on the PCB represents the analog common.



**Never connect the 2.5 VDC to power common (GND)**

### 2.2.2. Connecting to a Recorder

The following points must be considered when connecting the VE sensor to a recording system:

- In case of a voltage output the output range is 2.5 VDC to  $\pm 2.5$  V (i.e. 0 to 5 V range for peak to peak)
- In case of a current output the output range is 10 mA to  $\pm 10$  mA (i.e. 0 to 20 mA range for peak to peak).

### 2.2.3. Cable Configuration, Specification and Length

The cable configuration, specification, length and quality of installation affect the quality of analog signal received, the cost of materials and the long-term reliability of the system. When cabling is ordered as part of the system, GeoSIG engineers review the installation plan and the cable specifications as well as environmental conditions to assist you in achieving a reliable and cost effective installation. Following the guidelines outlined below will help further ensure your success.

A cable must not only be able to transmit power and signals, but must also survive the environment in which it is placed. This includes chemical exposure, UV exposure, impact and cut protection, temperature extremes and any regulatory safety requirements. Because the permutations are so numerous, it is not practical to specify particular manufacturer's cable part numbers here. However, GeoSIG engineers will work with you to help you specify an appropriate cable. The electrical parameters required for transmission of signals and power is discussed below.

The cable construction must be an overall shielded twisted pair type for optimal protection from electromagnetic interference (EMI) sources along the path of transmission. Normally the shield can be a foil wrapper with a drain wire. However, if the cable is to be installed in close proximity to high voltage power cables an overall braided shield is additionally recommended.

For optimum noise shield performance and maximum cable run lengths, the VE velocity sensor signals should be paired as shown on Table 4.

Table 4. Cable Wire Pair Assignments

Pair	Wire Pair Function
1	X-Signal high and low
2	Y-Signal high and low
3	Z-Signal high and low
4	S_Test and AGND
5	V_EXT and AGND
6	S_MODE and AGND

 **Connect the cable shield to the local ground at the recorder**

Cables do not generate noise. However, longer cables increase the amount of the contributed noise from external sources. Cables should always be routed as far from power distribution and control wiring as possible. Again, if the cable needs to be installed close to power cables, an overall braided shield is additionally recommended.

Cable resistance primarily determines the maximum cable length. This is not an issue related to analog signal degradation since both the signal currents and the transmission bandwidth are comparatively quite low. The main limitation is an outcome of voltage drop in the power supply due to cable resistance. The following table lists typical conductor resistance values for twisted pair shielded cables.

Table 5. Typical Twisted Pair Shielded Cable Specifications

Diameter mm	Square mm <sup>2</sup>	Resistance $\Omega$ /km	AWG
0.25	0.051	371	30
0.42	0.14	135	-
0.45	0.159	114	25
0.51	0.204	93	24
0.53	0.22	86	-
0.64	0.321	52	22
0.80	0.5	39	-
0.81	0.515	34	20
0.98	0.75	26	-
1.02	0.817	21	18
1.13	1.0	19	-

While selecting a cable, a maximum total resistance of 100  $\Omega$  should be taken into account and the values out of the table above must be doubled (forward and back path) to have the correct resistance value.

Cable length may be extended or a thinner cable might be used via utilizing several conductors for the VA+ and GND signal. Geophones using current loop output will draw 75 mA, maximum.

 Verify that voltage drop does not lower the voltage at the geophone to less than 10 VDC.

### 3. Operation and Configuration

#### 3.1. Axis Orientation Configuration

The axis orientation configuration is printed on each sensor's label that takes place on the housing. Geophones are sensitive to the gravity; therefore the VE velocity sensor has to be placed in accordance with the intended (and as purchased, i.e. horizontal or vertical) orientation.

 **Do not exchange the geophone axis orientation(s) without contacting GeoSIG. Doing so will void the warranty of the instrument and might as well damage it completely.**

 The polarity of the signal can be changed basically by exchanging the connections to the geophone. Also this action has to be coordinated with GeoSIG and must be executed by a skilled electrician.

#### 3.2. Scale Factor / Gain

The standard scale factor is 100 mm/s. Other ranges are available. A gain ranging option allows the user to select one of three scale factors by connecting S\_TEST and S\_MODE to VA+ or GND. See the following table.

Table 6. Scale Factor / Gain / Test; 0 = Ground, 1 = VA+

S-Mode	S-Test	Gain
0	0	Mid Gain
1	0	High Gain
0	1	Mid Gain with sensor test
1	1	Low Gain

#### 3.3. Self Test

When S\_MODE is grounded and S\_TEST is connected to VA+, the VE velocity sensor responds with a pulse. The pulse is positive and decays to zero after releasing the test input condition. This test is an excellent indication about the proper working of the sensor. Geophones might get damaged due to large shocks (e.g. by falling down to the ground). Such a damaged geophone would have developed internal



contact between the moving part and have the coil fixed. The self-test wave perfectly shows such a defect because the response on the self-test input would be completely different than the standard.

### 3.4. Operation Confirmation

Confirmation of the operation is easily accomplished with a few simple measurements, which involve checking of:

- the output voltage in normal operation,
- the power consumption,
- the wave-form of the test pulse.

## 4. Specifications

Please refer to the technical leaflet of your sensor.

## 5. Maintenance

The VE velocity sensors are sealed from the environment. As such, there is no routine or additional maintenance required. For critical and long-term applications we recommend the periodic use of the self-test functionality (see section 3.3. Self Test) to verify the integrity of the system and installation. In precision applications we recommend a calibration audit interval of 1 year. GeoSIG can execute a calibration check, which is executed by using an accelerometer with a hardware integrator as reference velocity sensor on a shaker.

## 6. Theory of Operation

The VE-1x/2x contains the following electronic blocks:

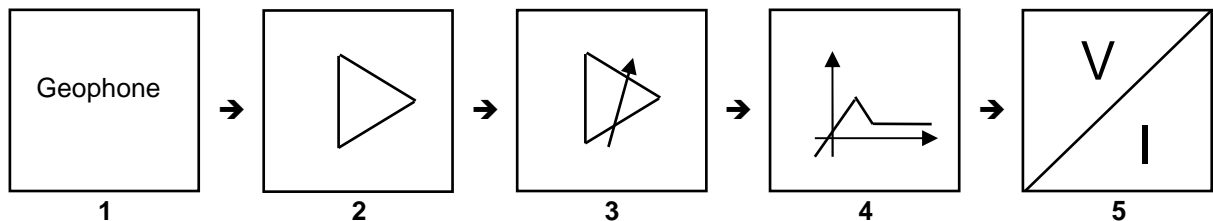

#### 1 Geophone

- Standard Geophone 4.5 Hz

#### 2 Signal Conditioner

- Damping Resistor
- Amplifier

#### 3 Gain Selection (Optional)

- 3 Gains selectable 1:10:100 (standard)
- other ranges optional

#### 4 Geophone Integrator

- Makes the 1 Hz response (only VE-1x)

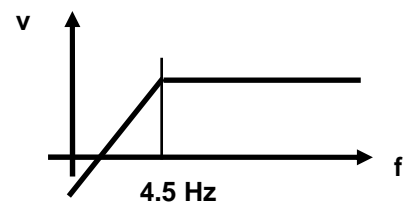

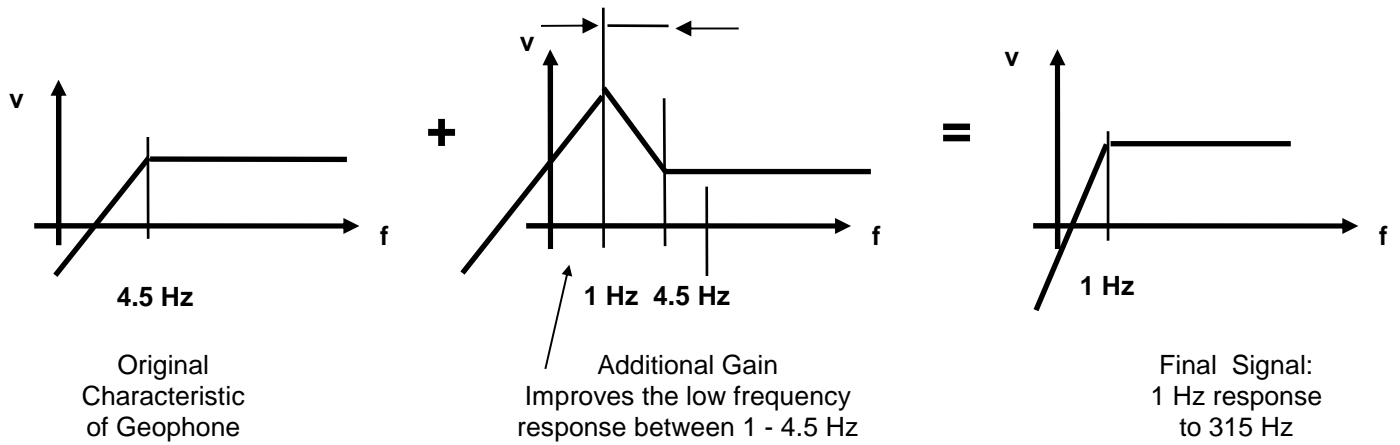

**5 Voltage to current converter (Optional-GS-320CL)**

- 0 – 20 mA