



 **ela**<sup>GMS series</sup>  
**User Manual**



GeoSIG Ltd, Wiesenstrasse 39, 8952 Schlieren, Switzerland  
Phone: + 41 44 810 2150, Fax: + 41 44 810 2350  
info@geosig.com, www.geosig.com

**Disclaimer**

GeoSIG Ltd reserves the right to change the information contained in this document without notice. While the information contained herein is assumed to be accurate, GeoSIG Ltd assumes no responsibility for any errors or omissions.

**Copyright Notice**

No part of this document may be reproduced without the prior written consent of GeoSIG Ltd. Software described in this document is furnished under a license and may only be used or copied in accordance with the terms of such a license.

**Trademark**

All brand and product names mentioned are trademarks or registered trademarks of their respective holders.

All rights reserved.

GeoSIG Ltd

Switzerland

# Table of Contents

<b>Applicability of This Manual</b>	<b>9</b>
<b>Warnings and Safety</b>	<b>10</b>
<b>GeoSIG Cybersecurity Recommendations</b>	<b>11</b>
<b>Symbols and Abbreviations</b>	<b>14</b>
<b>1 Introduction</b>	<b>15</b>
<b>2 Incoming Inspection</b>	<b>16</b>
2.1 Damage During Shipment . . . . .	16
2.2 Warranty . . . . .	16
2.2.1 Limitation of Warranty . . . . .	16
<b>3 Description</b>	<b>17</b>
3.1 Housing . . . . .	17
3.2 Connectors . . . . .	18
3.2.1 Standard External Connectors . . . . .	19
3.2.2 Optional External Antennas . . . . .	19
3.3 Visual Indicators . . . . .	20
3.4 Power Supply . . . . .	21
3.4.1 Choice of Power Supply . . . . .	21
3.4.2 Optional Accessories . . . . .	21
<b>4 Installation</b>	<b>22</b>
4.1 Site Selection . . . . .	22
4.1.1 Environmental Considerations . . . . .	22
4.1.2 Power Supply Considerations . . . . .	22
4.1.3 Communication Considerations . . . . .	22
4.2 Installation . . . . .	23
4.2.1 Mounting the Instrument . . . . .	23
4.2.2 Orientation, Leveling and Calibration of the Sensor . . . . .	24
4.2.3 Installing other Components, Options, Accessories . . . . .	25
4.3 First Start and Communication Setup . . . . .	26
<b>5 Quick Start Up</b>	<b>27</b>
5.1 Preparation . . . . .	27
5.2 Set IP Address of the Instrument . . . . .	28
5.3 No Stations Configured at first Start Up . . . . .	30
5.4 Adding New Stations . . . . .	30
5.5 Configuration of Data Server . . . . .	31
5.6 Basic Configuration of the Instrument . . . . .	33
<b>6 Principle of Operation of the Instrument</b>	<b>36</b>
6.1 Normal Operation . . . . .	36
6.2 Behaviour on a Seismic Event . . . . .	37
6.3 Firmware and Configuration Upgrade . . . . .	39
6.4 Backup Server . . . . .	40
<b>7 Network Settings</b>	<b>41</b>
7.1 Network Settings through the Web Interface . . . . .	41
7.2 Network Settings through GeoDAS . . . . .	43
7.3 Wired Ethernet settings through the local Console . . . . .	44
7.4 Wireless Settings through the local Console . . . . .	44
7.5 Get IP from Instrument . . . . .	46

<b>8</b>	<b>The Web Interface</b>	<b>48</b>
8.1	Accessing the Web Interface	48
8.2	The Home Panel and the General Navigation	49
8.3	Device Configuration	50
8.3.1	Data Acquisition Configuration	51
8.3.2	Configuration Manager	52
8.3.3	Network Configuration	53
8.3.4	Web Interface Configuration	55
8.4	State of Health	56
8.4.1	Error Status	56
8.4.2	Recording Status	57
8.4.3	Hardware Status	58
8.4.4	Software Status	59
8.4.5	Maintenance	60
8.5	Data Explorer	62
8.6	Help	63
8.6.1	Online Help	63
8.6.2	Contact GeoSIG Service	63
<b>9</b>	<b>Detailed Configuration of the Instrument</b>	<b>64</b>
9.1	Switch ON and OFF the Instrument	64
9.2	General Comments to the Configuration	64
9.2.1	Change Configuration by the Web Interface	64
9.2.2	Change Configuration by GeoDAS	64
9.2.3	Changing Configuration by the Console	64
9.2.4	Explanation of the Structure in the Manual	66
9.3	Configuration of the Channels	67
9.3.1	In the Web Interface or by GeoDAS	67
9.3.2	Via Local Serial Console	69
9.3.3	LSB factor	71
9.3.4	Channel Naming	71
9.4	Configuration of Data Streams	72
9.4.1	In the Web Interface or by GeoDAS	72
9.4.2	Via Local Serial Console	73
9.4.3	Set up of Data Streams	75
9.5	Trigger Settings	78
9.5.1	In the Web Interface or by GeoDAS	78
9.5.2	Via Local Serial Console	80
9.5.3	STA/LTA trigger	83
9.5.4	Trigger Weight	83
9.5.5	Trigger Time Frame	83
9.6	Preset Trigger Settings	85
9.6.1	In the Web Interface or by GeoDAS	85
9.6.2	Via Local Serial Console	86
9.7	File Storage and Policy	88
9.7.1	In the Web Interface or by GeoDAS	88
9.7.2	Via Local Serial Console	89
9.8	Communication Parameters	91
9.8.1	In the Web Interface or by GeoDAS	91
9.8.2	Via Local Serial Console	92
9.9	Miscellaneous Parameters	96
9.9.1	In the Web Interface or by GeoDAS	96
9.9.2	Via Local Serial Console	97
9.10	Time synchronization	104
9.10.1	In the Web Interface or by GeoDAS	104
9.10.2	Via Local Serial Console	105
9.11	GeoSIG Options	109
9.11.1	Via Local Serial Console	109
9.12	Other Options in the Instrument Main Menu	110
9.12.1	Control Requests	111

<b>10 Test and Configuration Menu</b>	<b>115</b>
10.1 Flash Images and Boot Options	117
10.2 Hardware Setup and Monitor	117
10.3 Test Functions	117
10.4 Security	117
10.5 Comparison of User Permissions	118
<b>11 Firmware Upgrade</b>	<b>119</b>
<b>Appendices</b>	<b>121</b>
<b>Appendix A Connector Pinouts</b>	<b>122</b>
A.1 POWER Connector	122
A.2 ETHERNET Connector	122
A.3 ALARM Connector	122
A.4 CONSOLE Connector	123
<b>Appendix B Remote Access to the Instrument over SSH</b>	<b>124</b>
B.1 SSH Clients for Linux OS	124
B.2 SSH Clients for Windows OS	125
B.3 SFTP access for Windows OS	126
B.4 File Structure of the Instrument	127
<b>Appendix C GeoDAS Settings</b>	<b>128</b>
C.1 Configuration of Stations	128
C.1.1 Add a new Instrument	129
C.1.2 Remove an Instrument	129
C.2 Configuration of Server Parameters	130
C.3 Instrument Control in GeoDAS	131
C.3.1 More Information... (State of Health of the Instrument)	131
C.3.2 Instrument Setup...	132
C.3.3 Cancel Pending Request	132
C.3.4 Instrument Communication Interface	132
C.4 Open recorded miniSEED files in GeoDAS	133
C.4.1 Save predefined Scaling Factors	134
C.4.2 Calculation of the Scaling Factors	135

## Table of Tables

1	Indicators description . . . . .	20
2	The overall error states shown in the Web Interface . . . . .	49
3	Explanation table structure . . . . .	66
4	Channel configuration menu structure . . . . .	70
5	Data streaming configuration menu structure . . . . .	74
6	Trigger settings configuration menu structure . . . . .	83
7	Preset trigger configuration menu structure . . . . .	87
8	File Storage and Policies menu structure . . . . .	90
9	Communication Parameters menu structure . . . . .	94
10	Server Parameters menu structure . . . . .	95
11	Miscellaneous Parameters menu structure . . . . .	103
12	Time Synchronization Parameters Menu Structure . . . . .	107
13	GeoSIG options menu structure . . . . .	109
14	Other options in the main menu . . . . .	110
15	Control requests . . . . .	113
16	Comparison of test and configuration menu users . . . . .	118

## List of Figures

1	Instrument housing	17
2	Instrument with all connectors. Antennas are not mounted	18
3	Power supply	21
4	Direct installation on wall or floor	23
5	Installation with the base plate	24
6	Sensor orientation configuration	25
7	GeoDAS terminal	27
8	"No stations configured" message at startup of GeoDAS	30
9	Instrument wizard	30
10	Quick Login Window	31
11	List of all stations found - single station left, multi-selection right side	31
12	Configuration and overview of the stations	31
13	Data server parameter	32
14	Instrument setup	33
15	Web Interface of the selected instrument	33
16	Communication parameters	34
17	Edit Communication parameters	34
18	Edit Server parameters	35
19	Normal operation in a network	36
20	Upload of seismic events and download of requests from the server	37
21	Behaviour on Events: Upload of extracted events	38
22	Firmware upgrade	39
23	Connection to backup server in case connection to main server fails	40
24	Configuration of network interface	42
25	Configuring Stations screen	43
26	Edit Network settings	43
27	Configuration of wired Ethernet	43
28	Configuration of wired Ethernet	44
29	The login screen of the instrument at 192.168.30.176	48
30	The home panel of the web interface	49
31	Configuration main menu	50
32	Configuration panels	51
33	Configuration Manager screen	52
34	Choose new file to upload	52
35	Configuration file is now uploaded	53
36	File is uploaded	53
37	Network Configuration Screen	54
38	Web Interface Configuration Screen	55
39	Error Status Screen	56
40	Recording Status Screen	57
41	Hardware Status Screen	58
42	Software Status Screen	59
43	The Maintenance Screen	60
44	Seismometer Control	61
45	The Data Explorer Screen	62
46	Download the GMsela User Manual	63
47	Contact information	63
48	Instrument setup	65
49	Configure Number of Channels	67
50	Edit Channel Parameters	68

51	Configure number of Output Streams . . . . .	72
52	Edit Stream Parameters . . . . .	72
53	Channels of Digitizers . . . . .	76
54	Stations: Data Streams . . . . .	76
55	Data stream window . . . . .	77
56	Configure number of trigger sets . . . . .	78
57	Edit Trigger Parameters . . . . .	79
58	Overview of trigger weight and trigger time frame . . . . .	84
59	Configure number of Preset Triggers . . . . .	85
60	Edit Preset Triggers . . . . .	86
61	File Storage Settings . . . . .	88
62	Communication Parameters . . . . .	91
63	Edit Communication Parameters . . . . .	92
64	Miscellaneous Parameters . . . . .	96
65	Edit Miscellaneous Parameters . . . . .	97
66	Time synchronization Parameters . . . . .	104
67	Edit Time synchronomization Parameters . . . . .	105
68	Select Instrument Control . . . . .	119
69	instrument Communication Interface . . . . .	119
70	Pending upgrade on the server . . . . .	120
71	Alarms wiring diagram . . . . .	123
72	Command line SSH client at terminal emulator . . . . .	124
73	Configuration window of PuTTY . . . . .	125
74	TeraTerm Connection Window . . . . .	125
75	WinSCP login window . . . . .	126
76	Explorer mode of WinSCP when connected to the instrument . . . . .	126
77	Configuration Stations . . . . .	128
78	Add Station to Current Configuration . . . . .	129
79	Remove Station from Current Configuration . . . . .	129
80	Station server parameters . . . . .	130
81	Instrument control of the station in GeoDAS . . . . .	131
82	SOH information in GeoDAS . . . . .	131
83	Instrument Communication Interface . . . . .	132
84	GeoDAS miniSEED parameters . . . . .	134
85	GeoDAS analysis parameters . . . . .	134



## Applicability of This Manual

GMSEla Instruments are constantly being improved. Although the manual you receive along with your instrument corresponds to the actual software versions, **you are advised to check [www.geosig.com](http://www.geosig.com) periodically for the most recent version of this document**, and especially after performing any software upgrades. This manual is based on the following software and firmware versions:

Component	Description	Required version or higher
GeoDAS	Data acquisition and analysis software on the computer	2.40
armdas	Data acquisition software of the instrument	28.01.09
SUP	Power supervisor	90.01.06
DSP	Digital signal processor	128.05.01
Web Interface	Web Interface	1.14
Linux OS	Kernel Version	4.9.52

## Warnings and Safety

### **STATIC ELECTRICITY**

*The instrument and its sensor unit (if available) contain CMOS devices, and when serviced care must be taken to prevent damage due to static electricity. This is very important to ensure long-term reliability of the unit. Such risk exists when both the housing lid and the internal panel are removed.*

### **INSTALLATION SITE**

*This instrument is designed for highly specialized applications. If installed in publicly accessible areas it is the responsibility of the instrument owner to ensure that the device is installed in a safe and secure manner.*

*The instrument should be installed in a well ventilated place and when possible be protected from direct sunlight and heat.*

*The housing provides no protection against explosive atmosphere. The instrument must not be operated without necessary protective measures (e.g. EX-proof housing) in an area where explosive gases could be present.*

### **CLEANING**

*Disconnect the power from the instrument prior to cleaning. Do not remove the housing lid during cleaning. Wipe all exterior surfaces with a damp cloth. Use mild detergent if required. No water should be used if cleaning inside the instrument is required.*

## GeoSIG Cybersecurity Recommendations

GeoSIG instruments, as described in their documentation, have built-in security and safety features against unauthorised access or use. However, ultimately it is the user's responsibility to ensure the safe and secure usage of our instruments based on their actual implementation. No factory delivered solution can fit each and every possible scenario. The user is advised herein that once you connect a device to a network, you are also connecting that network to that device. It is the responsibility of the user to take appropriate precautions so that all devices should be adequately hardened, such as with individual strong passwords, and should have their traffic monitored and managed via appropriate security features, such as firewalls. Also, non-critical devices should be segmented away from networks that contain sensitive information.

Compliance with a well-defined security procedure helps protect not only an individual device, but also other devices connected through the network. Such procedure would be intended to prevent exploitation of an individual device's resources by unauthorized individuals, including the use of such device to attack other systems on the network or the Internet.

The following recommendations can be considered in establishing such a security procedure:

### 1. Physical access restriction

All devices must be restricted from unauthorised physical access and a well-defined physical access procedure shall be utilised.

### 2. No Unattended Console Sessions

Except for the devices which are physically secured, no unattended console sessions shall be left running.

### 3. No Unattended Network Sessions

No unattended user interface sessions shall be left running towards any device accessed through its network interface.

### 4. Use of a Firewall

For a network that has any connection to the outside world, a hardware firewall must be running and configured to block all inbound traffic that is not explicitly required for the intended use of the network and the connected devices. The user can also consider limiting outbound traffic.



***Any communication ports that are required for the operation must be protected.***

### 5. No Unnecessary Services or Ports

If a service or port is not necessary for the intended purpose or operation of the device, that service must not be running and the port must be closed. (e.g. if seedlink server is running, but not used, turn it off)

### 6. Use of authentication

Network and console device access must require authentication by means of strong and individualised passwords per device (no passe-partout passwords).

Wireless access must require strong encryption to associate (such as WPA2), or some other strong mechanism to keep casual users near the access point from using it to get full access to the network. WEP or MAC address restrictions do not meet this requirement.

### 7. Password complexity and security

When passwords are used, they must meet the specifications similar to below:



***All default passwords must be changed at time of initial access or latest at deployment into service.***

Passwords MUST:

contain eight characters or more

contain characters from AT LEAST two of the following three character classes:

Alphabetic (e.g., a-z, A-Z)

Numeric (i.e. 0-9)

Punctuation and other characters (e.g., !@#%&^&\*()\_+|~-=\‘{ } [ ] : " ; ’ < > ? , . /)

## **8. Privileged Accounts**

Privileged and super-user accounts (Administrator, root, etc.) must not be used for non-administrator activities. A secure mechanism to escalate privileges with a standard account is acceptable to meet this requirement. Network services must run under accounts assigned the minimum necessary privileges.

## **9. No Unencrypted Authentication**

All network-based authentication must be strongly encrypted. In particular, insecure services such as Telnet, FTP, SNMP, POP, and IMAP must not be used or must be replaced by their encrypted equivalents.





## **10. Software / Firmware updates**

Networked devices must only run software/firmware that are updated according to supplier’s guidelines. A periodical check of any available updates from the supplier must be sought.

**Please contact GeoSIG Ltd if you require any further advice or clarification.**



## Symbols and Abbreviations

ADC	Analog to Digital Converter
ARM	Main processor
armdas	GeoSIG data acquisition software
Bootloader	First program executed when unit starts
CF	Compact Flash, memory card using Flash memory
Compact Flash	See CF
DSP	Digital Signal Processor in charge of controlling the ADCs
GSIAFW	GeoSIG data acquisition software.
EEW	Earthquake Early Warning
Flash	Program storage memory device. It contains the Linux file system in Read Only mode and some block areas under direct control of main program or bootloader
FTP	File Transfer Protocol
GPS	Global Positioning System
GUI	Graphical User Interface
IMAP	Internet Message Access Protocol
LAN	Local Area Network, a simple branch of private network using private IP address. It could have or not have access to Internet (WAN)
NTP	Network Time Protocol
POP	Post Office Protocol
PPS	Pulse Per Second
RAM	Random Access Memory
RTC	Real Time Clock
SD	Secure Digital Memory Card
SNMP	Simple Network Management Protocol
SPS	Samples Per Second
SSH	Secure Shell
SSID	Service Set Identifier. This is the identifier name of a wireless network.
STP	Shielded Twisted Pair
SUP	Supervisor in charge of controlling the power management.
Telnet	Teletype network
USB	Universal Serial Bus
UTP	Unshielded Twisted Pair
VPN	Virtual Private Network
WAN	Wide Area Network. It is a network connection established between 2 LAN or a LAN and a server over the internet (usual case) or through a rented link.
WPA	Wi-Fi Protected Access. It is a secure specification that allows users to access information instantly via wireless link. It is a more modern and secure link than the WEP type.
WEP	Wired Equivalent Privacy
	Important information related to the current section.
	Caution. Refer to the instructions next to the marking, or refer to the relevant section of this user manual.
	Direct current. This symbol indicates a direct current (DC) power line derived from an alternating current (AC) power source.
	Earth terminal.
	CE. This symbol indicates that the device conforms to all legal requirements needed to achieve free movement and sale of the product through the European Economic Area (EEA).

# 1 Introduction

Dear Valued GeoSIG Customer, thank you for purchasing this product.

These instruments have been optimised to meet the requirements of the majority of customers out of the box and may have even been delivered tailored to your needs. In any case, to be able to get the most out of our product, please carefully study this manual, its appendices and referenced manuals, as well as any other documents delivered with it.

This is a reliable and easy-to-use device, and at the same time a sophisticated product that requires care, attention and know-how in configuring, installing, operating and maintaining.

GeoSIG continually improves and enhances capabilities of all products. There may be several other connectivity, hardware or software options for the instrument, which are not covered in this manual. Refer to separate documentation from GeoSIG about available options or ask GeoSIG directly.

## 2 Incoming Inspection

All instruments are carefully inspected both electrically and mechanically before they leave the factory. Please check if all received items correspond with the packing list and your order confirmation. In case of discrepancy please contact GeoSIG or your local representative immediately.

### 2.1 Damage During Shipment

If requested at the time of order, all instruments can be insured prior to shipment. If you receive a damaged shipment and shipping insurance was previously arranged you should:

- Report the damage to your shipper immediately
- Inform GeoSIG or your local representative immediately
- Keep all packaging and shipping documents

Insurance claims may be void if the above procedure is not followed.

### 2.2 Warranty

GeoSIG Ltd (hereafter GeoSIG) warrants hardware and software products against defects in materials, workmanship and design for the defined period in the relevant contract or offer, starting from date of shipment and 5 years parts and maintenance support commitment. If GeoSIG receives notice of such defects during the warranty period, GeoSIG shall at its option either repair (at factory) or replace free of charge hardware and software products that prove to be defective. If GeoSIG is unable—within a reasonable time—to repair or replace any cabinet to a condition as warranted, buyer shall be entitled to a refund of the purchase price upon return of the cabinet to GeoSIG. 50% of freight charges on shipments of warranty repairs or replacements will be borne by GeoSIG (normally one way freight).

#### 2.2.1 Limitation of Warranty

The foregoing guarantee shall not apply to defects resulting from:

- Improper or inadequate maintenance by buyer
- Buyer supplied software or interfacing
- Unauthorised modification or misuse
- Operation and storage outside of the environmental specifications of the instrument
- Related to consumables or batteries
- Improper preparation and installation at site.



## 3 Description

### 3.1 Housing

The compact and robust design allows GMSeLa to be used as part of a large deployment for EEW, as well as giving the ability to stream real-time data and record with multiple filtering options and embedded adjustable triggering algorithms. It is an asset in damage estimation and disaster management.

GMSeLa monitors ground motion in three orthogonal axes. It is a compact and robust instrument, designed for large scale deployment for indoor and outdoor installation.

This instrument can be floor or wall mounted, see chapter 4.

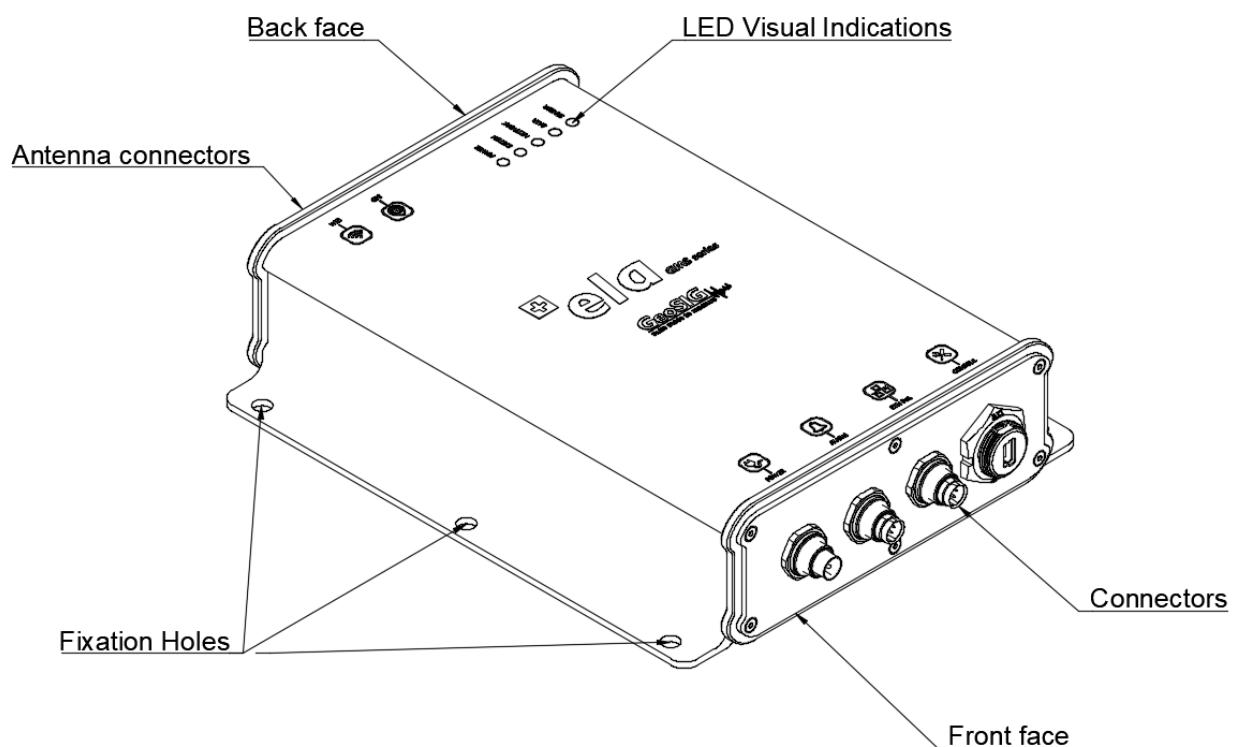

Figure 1: Instrument housing

### 3.2 Connectors

The instrument has up to four connectors on bottom cover and two antenna plugs on top cover:

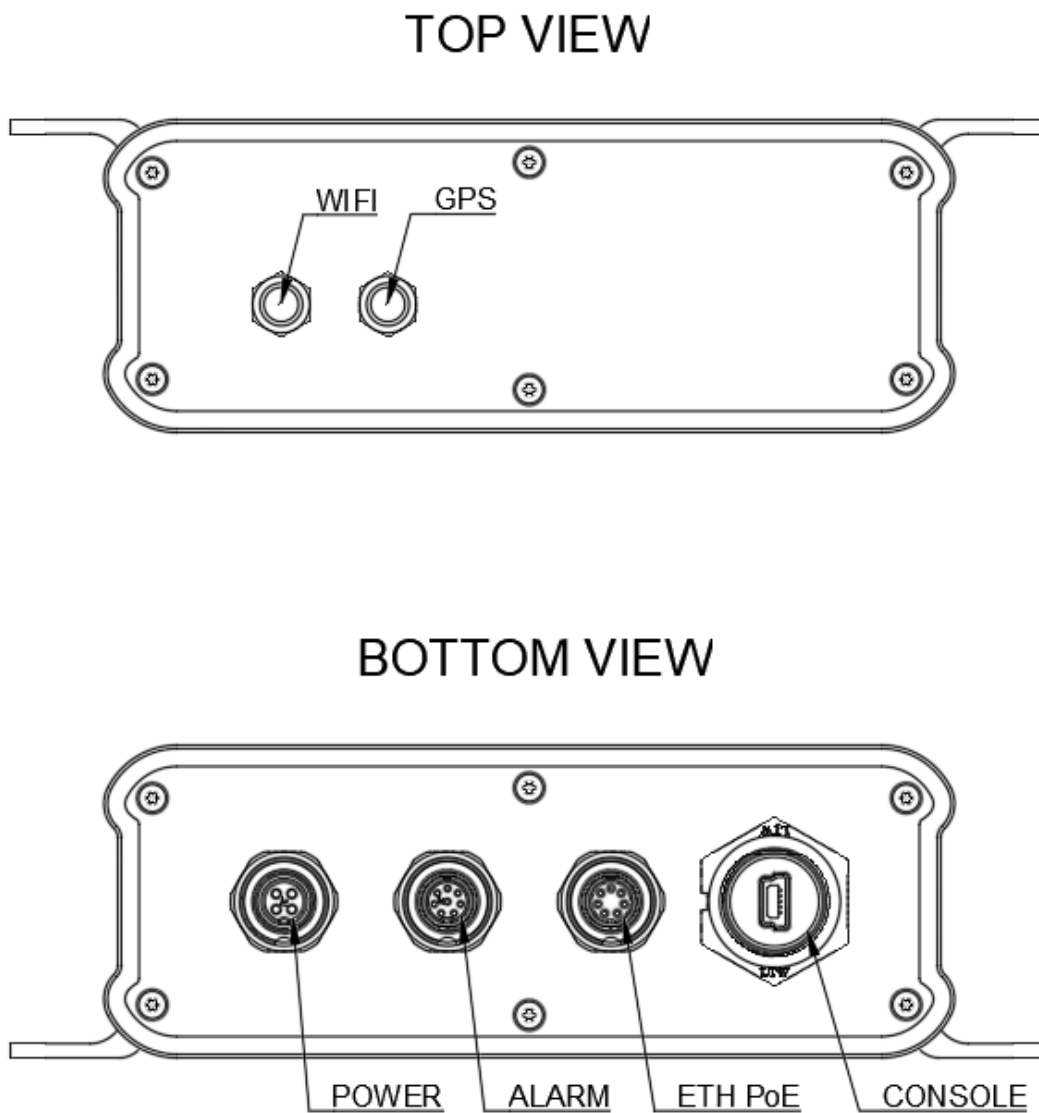

Figure 2: Instrument with all connectors. Antennas are not mounted

### 3.2.1 Standard External Connectors

These connectors always will be assembled:

- POWER Connection to the power supply module of the instrument or to an external battery.
  
- ETH PoE Connection with Ethernet cable to a LAN. The cable connection is dominant over the Wi-Fi link. As soon as the cable connector is plugged in the instrument ETHERNET socket, the Wi-Fi module will be turned off, even if the RJ45 connector at the end of the cable is not plugged into any socket.
  
- CONSOLE Connection to the console (Only for service or maintenance purpose)

### 3.2.2 Optional External Antennas

- ALARM Connection for external alarm.
  
- Wi-Fi Antenna connector for wireless network.
  
- GPS Antenna connector for optional internal GPS receiver.

### 3.3 Visual Indicators

The instrument includes five LEDs to indicate information about its status. POWER, SYSTEM, NETWORK, DATA and SENSOR LEDs are visible from outside. Table 1 describes in detail the meaning of the LEDs activity.

LED	LED state	Instrument status
POWER	Green solid	Power is available from AC/DC power supply or from PoE
SYSTEM	White solid	Linux OS is starting up
	White flashing	Data acquisition software is starting up
	Green flashing	Operational and synchronized to local time source(RTC)
	Blue flashing	Operational and synchronized to external time source(NTP or GPS)
	Yellow flashing	Operational but a warning has been issued
	Red flashing	Operational but an error has been detected
	Red solid	Instrument is not turning on because of high temperature. See <a href="#">9.1</a> Data acquisition software has stopped
NETWORK	Green solid	Network connection is available
	Blue flashing	Data transmission in progress
	Red solid	Network error
DATA	Green solid	No events recorded in the memory
	Yellow flashing	An event is being recorded
	Blue solid	Events are recorded in the memory
SENSOR	White flashing	Data acquisition is being configured
	Green solid	Data acquisition is ready
	Blue flashing	Data acquisition in progress
	Yellow flashing	Non critical data acquisition problem occurred
	Red flashing	Critical data acquisition problem occurred

Table 1: Indicators description

## 3.4 Power Supply

### 3.4.1 Choice of Power Supply

The main power should be provided to the instrument from a 9 to 48 VDC supply. The optional AC/DC power module provides 15 VDC at 1.2A unless otherwise specified. The AC entry is compatible with 110 / 60 Hz or 230 / 50 Hz network without any adjustment. The block has a C7 connector and can use any standard power cord with such connector. The power module and the power cord supplied are both CE and UL approved. The power module must be connected to AC with a 2-wire power cable providing Phase and Neutral.

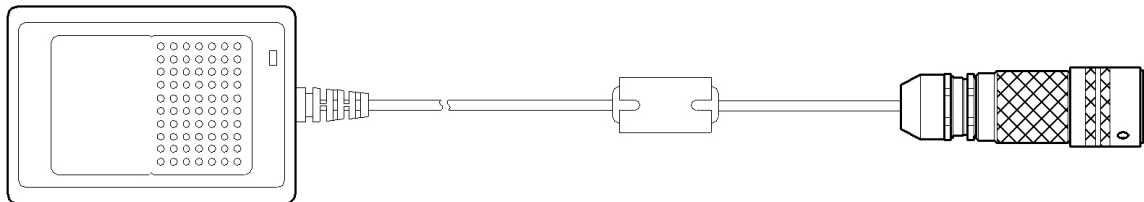

Figure 3: Power supply

The following parts will be included in a shipment in addition to the instrument:

- **Ethernet cable**, category 5 cable for 10/100 Mbit network with a suitable connector for the instrument, 2 meters of cable and a standard RJ45 connector. Other cable lengths are available by request.
- **Console cable** for use on the external CONSOLE connector

### 3.4.2 Optional Accessories

The following parts can be ordered additionally and will be added if specified at order time:

- External **power supply** module, 100 to 230 VAC / 50-60 Hz, CE and UL approved
- External **power supply cable** with open-end leads
- **AC power cable**, depending on the shipping address with European, US or Swiss power plug
- **GPS** time code receiver antenna with 5 meter cable, other cable length on request. GPS is an option as the time can also be synchronised through the network using NTP
- **Alarm card interface** with open connector and open-end leads
- **Wi-Fi** module and antenna
- **4G Modem** module with antenna (excl. SIM card)
- Any **spare antennas**

## 4 Installation

This section lists the procedures involved in installation of the instrument. The procedures will be outlined as steps to be performed in the field or in-house prior to deploying the instrument in the field.

### 4.1 Site Selection

#### 4.1.1 Environmental Considerations

The choice of an installation site for a seismic event recorder is similar in most respects to that of a regular continuous recording seismic station.

Although the instrument is housed in a solid, weatherproof case, it should be installed in a place free from direct sunlight, precipitation, the danger of falling materials in the event of a severe earthquake and the risk of tampering or vandalism if the unit is to be left unattended.

There are also special considerations for event recorder installations. It is important to select the site and set the trigger level to avoid unwanted data recording, such as vibration from machinery, highway traffic, aircraft, waves, etc. It is wise to check the instrument frequently during the first several days of operation after each set-up, to see if there are previously unsuspected sources of noise which are triggering the instrument and using up the memory.

You should make note at this point of any cultural or environmental sources of noise and vibration around the selected site, which may cause false triggers of the recording mechanism. These will have to be considered when setting the trigger parameters.

The operating temperature of the instrument itself is -20 °C to +70 °C. Nevertheless, if any additional internal or external accessories/modules with lower operating temperature ranges are used, the operating temperature of the combined system will be then limited by the temperature characteristics of these accessories/modules.

#### 4.1.2 Power Supply Considerations

The instrument may be powered from a 115 / 230 VAC supply through an external AC/DC converter which provides 9 to 48 VDC output, from an external battery, or optionally from solar panels.

- If the supply in the field will be from a 115 / 230 VAC supply, you need to connect the VAC cable from the external AC/DC to the power source only. The instrument operates continuously, providing a trickle charge to the internal battery, if supplied. The VAC supply must consist of Phase and Neutral.
- If the supply in the field will be from a 9 to 48 VDC supply, you need to connect the power cable from instrument to the power source only.
- It is highly recommended to check and configure the instrument for the correct time, trigger and other relevant settings in the lab, prior to the installation (see chapter 5). It may then be carried to the remote site and then connected to the VAC power through the external AC/DC converter or directly to the VDC power supply. After powered the instrument starts automatically (see chapter 9.1), the instrument runs with the pre-configured parameters. This reduces the amount of time needed to configure in the field – an important consideration in the case of an adverse condition.

#### 4.1.3 Communication Considerations

An Ethernet connection or Wi-Fi signal must be present to have data communication. If the instrument uses an NTP Server as time source, please make sure that an internet connection is available and the network settings are properly set in the instrument. If the instrument is used as a stand-alone recording station, a notebook with an Ethernet connector can be used for downloading the data on a regular basis. In a network the stations will upload the data to the configured server.

## 4.2 Installation



For your convenience a training video explaining the installation of the instrument is available at [www.geosig.com](http://www.geosig.com) → **Support** → 'How To ...' Videos



Many times the locations of seismic equipment are highly exposed to electrical disturbances caused by lightning or by the industrial environment. Although the instrument contains over voltage protection, it may sometimes be necessary to use additional surge protectors for the equipment. Contact GeoSIG or your local representative for more information.

### 4.2.1 Mounting the Instrument

#### 4.2.1.1 Space requirements for the installation

Minimum surface area requirements:

25 x 15 cm

#### 4.2.1.2 Direct mounting of the instrument

The instrument is designed to be directly installed on any flat surface like a structural wall or the floor.

Drill six holes with 6 mm diameter in the concrete with a typical depth of 50 mm for the supplied M4 screws (A) and anchor (B). If another model is used, please adapt the hole dimensions accordingly. Clean the hole area of the dust. Insert the anchor into the hole. If needed, use the provided washers to level the installation surface.

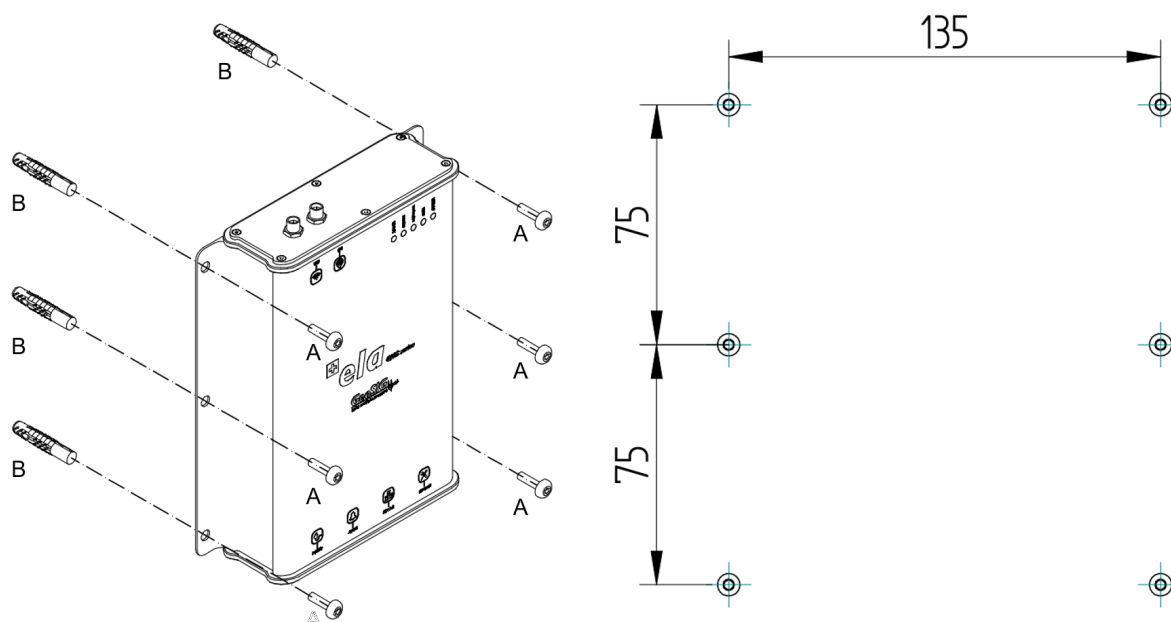

Figure 4: Direct installation on wall or floor

#### 4.2.1.3 Mounting the instrument with the base plate (Optional)

The unit must be fixed rigidly on the building foundation or structural wall; as option, a base plate can be provided to level the instrument to the installation surface. The base plate must be first fixed on the floor, ceiling or wall and then the instrument mounted on it. For that purpose, the base plate has a central fixation hole (suitable for 8 mm screws) and three leveling screws. Prepare the base plate:

- Mount the three leveling screws (A).
- Check that the four M4 threads for the instrument fixation are free from dust.

Place the base plate at the selected location. Verify that the surface is sufficiently flat and vertical so that the three feet can level the plate. Be sure to leave enough space at the front of the instrument for the connectors. The sides of the instrument should typically not be closer than 100 mm (4 inches) from a wall. Mark on the wall the location of the central hole in the plate. Remove the base plate.

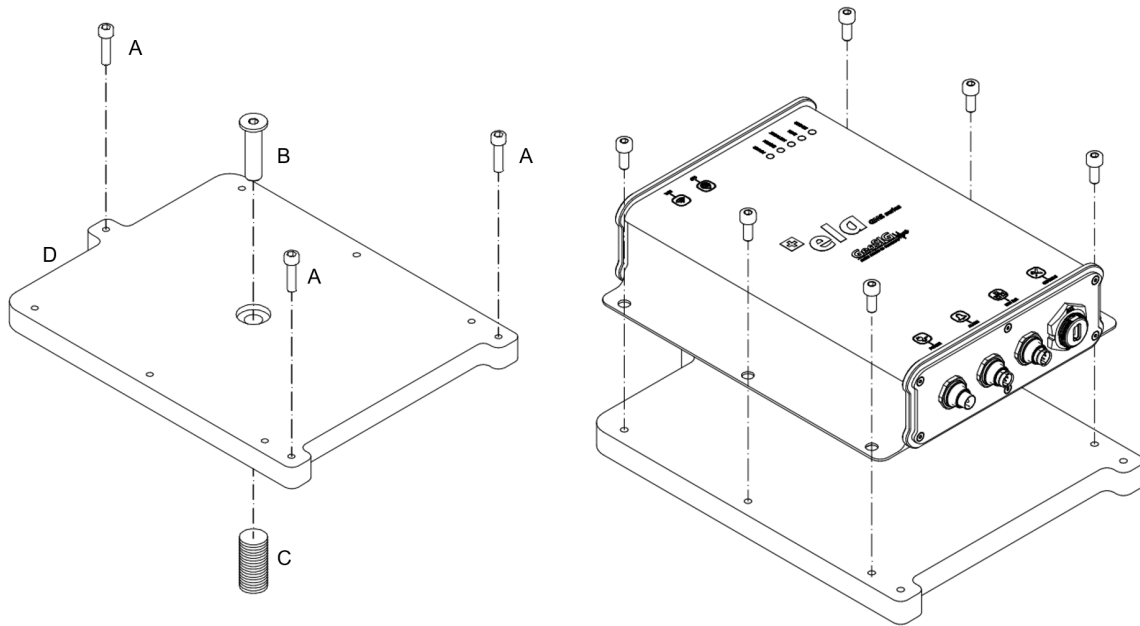

Figure 5: Installation with the base plate

Drill an 11 mm hole in the concrete with a typical depth of 50 mm for the supplied M8 concrete anchor (C). If another model is used, please adapt the hole dimensions accordingly. Clean the hole area of the dust. Insert the concrete anchor into the hole. Mount the plate in place and insert the M8 fixation screw (B) in its hole. Turn the plate so it is oriented according to requirement. Make a coarse leveling of the plate (D). Start fixing the plate by tightening the M8 central screw (B). Check regularly the plate orientation and level until the plate is rigidly fixed (D). Now the instrument can be placed on the mounting plate using the six screws and washers to fix it.

#### 4.2.2 Orientation, Leveling and Calibration of the Sensor

The correct fixation of the device can be verified by pushing from all directions. If you feel any movement, recheck the fixation.

The instrument itself can be mounted in any orientation desired. The acceleration sensor is located inside the housing and there is no need to remove the top or bottom cover to adjust the orientation.

Nevertheless for most applications it is important that the internal sensor is aligned according to the requirements. This can be done using the axes label on the wall of the instrument. In case the axes shall be aligned according to the global coordinate system, the Y-axis must point direction north. So X-axis corresponds then to East-West, Y-axis to North-South and Z-axis to Up-Down.

The gravity offset compensation can be adjusted via software during start-up of the instrument. By default the instrument is set for wall mounting. To change the orientation of the sensor, follow the instructions:

- If the instrument is on and running, send the command to reboot the instrument, otherwise switch on the instrument (See chapter 9.1).
- Press **'Ctrl + Z'** as soon the following message appears on the console to enter the test mode.

```
#####
##### Test and Initial Configuration Mode #####
#####
Press Ctrl+Z to enter the test mode.....
```



The following menu will appear (see chapter 10 for details):

Level	Shortcut	Password	Description
User	Ctrl+U	None	Basic operations only
Powerful User	Ctrl+W	None	Also hardware options and pre-selected tests
Administrator	Ctrl+A	None	Also manual tests and altering the FLASH memory content

Your level [U/W/A] or press B to boot now:

- By default no passwords are set, so press 'W' to enter the Powerful User Mode
- Go to the sub-menu **K - Instrument hardware parameters** → **D - Sensor parameters** → **L - Sensor orientation**.
- Choose the proper configuration according to the actual sensor orientation and installation type.

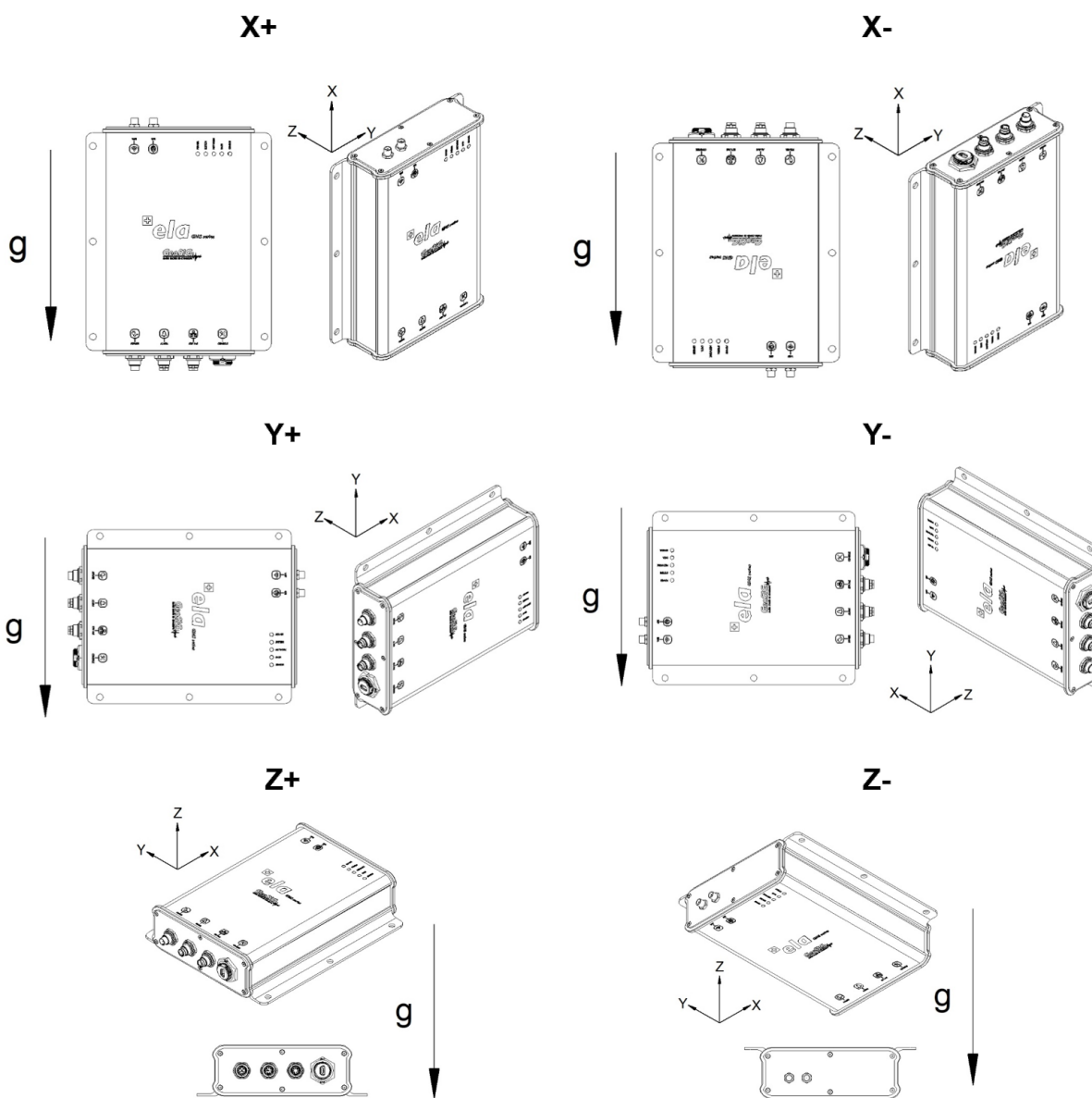

Figure 6: Sensor orientation configuration

#### 4.2.3 Installing other Components, Options, Accessories

For installation of other components options or accessories please refer to the specified option manual.

### **4.3 First Start and Communication Setup**

With the instrument correctly fixed on the ground or on the wall through the fixation plate please proceed with chapter 5 for the first start-up and configuration.

## 5 Quick Start Up

This chapter is intended to configure simple communication between the instrument and *GeoDAS* software running on a Windows workstation, working as data server.

 *It is assumed that the GeoDAS software is already installed on a computer. If not, please do the installation first with help of the [GeoDAS User Manual](#) before proceeding.*

### 5.1 Preparation

- Make sure the instrument is powered by the provided power supply. (The instrument will start when power supply is applied).
- Make sure the instrument is connected to a LAN by the supplied Ethernet cable.
- If installed, verify that the battery is correctly fixed and connected to the system.

 *In case there is no LAN available, the Ethernet cable can be connected directly to a computer. For this a crossed Ethernet cable is needed; please contact GeoSIG. Nevertheless in modern computers normally it works as well with the supplied patch cable.  
In any case the instrument and the computer must be configured to have a fixed IP. Please follow the procedure to adjust these settings.*

- Connect the instrument to a USB port of your computer by using a standard Mini USB patch cable.
- Open any terminal program and choose the appropriate COM port. Baud rate is 115200. Alternatively open *GeoDAS*, go to **Tools** → **Terminal ...** and choose the COM Port. As Baud rate select **115200**. Then Press **Connect**

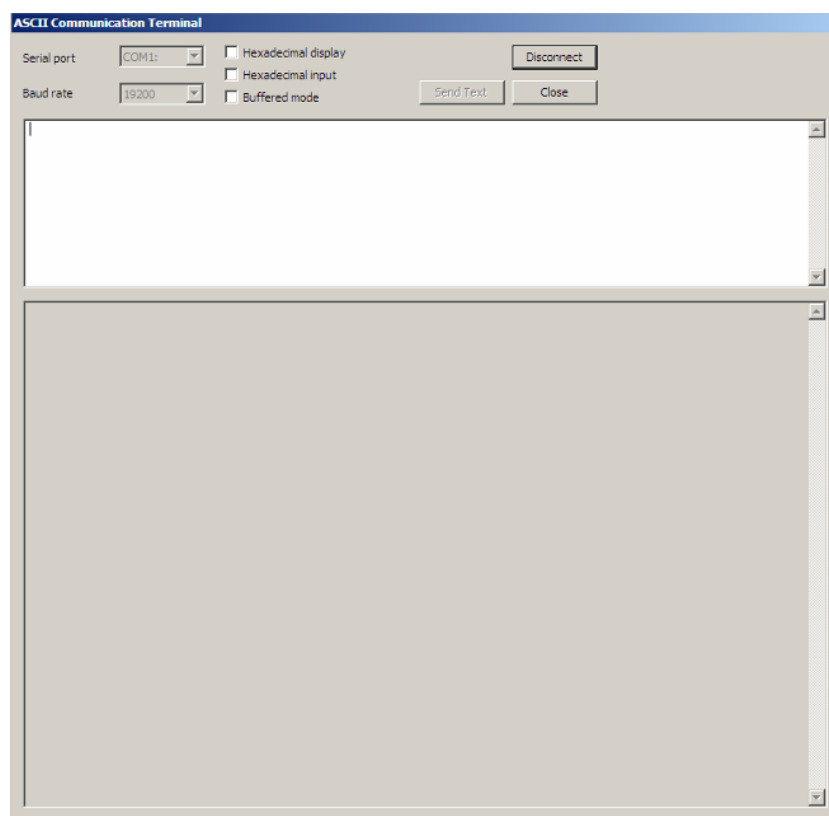

Figure 7: GeoDAS terminal

- Keep the terminal open for the next step.

## 5.2 Set IP Address of the Instrument

Network settings of the instrument can be changed during startup of the instrument. By default the instrument has a dynamic IP.

- If the instrument is on and running, send the command to reboot the instrument, otherwise switch on the instrument (See chapter 9.1).
- Press **'Ctr + Z'** as soon the following message appears on the console to enter the test mode.

```
#####
##### Test and Initial Configuration Mode #####
#####
Press Ctrl+Z to enter the test mode.....
```

The following menu will appear (see chapter 10 for details):

```
-----
Level          Shortcut Password Description
-----
User           Ctrl+U   None    Basic operations only
Powerful User  Ctrl+W   None    Also hardware options and pre-selected tests
Administrator Ctrl+A   None    Also manual tests and altering the FLASH memory content
-----
Your level [U/W/A] or press B to boot now:
```

- By default no passwords are set, so press **'U'** to enter the User Mode, and then **'N'** to enter the menu Network settings.

```
==== Network Settings ====

---- Primary network interface ----
Configure network interface (Y/N)? Y
Static IP address (1=YES, 0=AUTO)? (0 = 0x0):
```

- Select **'Y'** to change the settings and then select if the instrument should have a static or a dynamic IP by pressing **'1'** (Static) or **'0'** (dynamic). In case a dynamic IP is chosen, a DHCP server must be available in the network to provide the IP settings.
- In case a static IP is selected, an additional message will appear asking for the instrument IP address, instrument network mask and instrument gateway IP. If you don't know these parameters please ask your network administrator.
- If the instrument has a Wi-Fi module, a second interface menu appears. Here static or dynamic IP can be chosen and the available Wi-Fi networks can be scanned. Please see chapter 7.4 for details.

```
---- Wireless network interface ----
Configure network interface (Y/N)? Y
Static IP address (1=YES, 0=AUTO)?
```

- If the instrument is connected to the Internet via a PPP connection (cellular or analog modem), then the APN and password must be configured. See chapter 7.4 for details.

```
---- PPP Communication ----
Edit Analog Modem settings (Y/N)? Y
Phone number of the service provider [T313001]:
Login [demo]:
Password [demo]:
Updating configuration...
PPP settings have been updated
Edit Cell Modem settings (Y/N)? N
```

- The instrument allows access to the operating system from remote over SSH. This feature is not needed for normal operation of the instrument and can be disabled in case of security concerns. By default it is

enabled; to disable press **'1'**.

```
---- Miscellaneous parameters ----  
Disable remote login over ssh (1=Yes, 0=Enable)? (0 = 0x0):
```

- It's highly recommended to put a *recovery server IP address and recovery server port*. The instrument will contact this server every *Recovery server contact interval* in case the connection to the main data server (configured in the configuration of the instrument) is not possible anymore. This could happen, for example, if a configuration file with wrong server settings were accidentally uploaded to an instrument.

```
Recovery server IP address (192.168.10.107):  
Recovery server port (3456 = 0xD80):  
Recovery server contact interval, hours (24 = 0x18):
```

- As soon the following menu appears, press **'5'** to start the instrument.

```
Access level: User  
  
--- Flash Images and Boot Options ---  
L - List flash images  
Q - Reset instrument configuration to the user default  
V - Reset instrument configuration to the factory default  
5 - Boot now  
X - Reboot the instrument  
Y - Power off  
  
--- Hardware Setup and Monitor ---  
N - Network settings  
  
--- Security ---  
0 - Set password  
  
-->
```

- Start **GeoDAS** (if not already done), to add the instrument in its configuration

### 5.3 No Stations Configured at first Start Up

👉 | The following steps require GeoDAS version 2.24 or higher. If you have an older version download the newest release from [www.geosig.com](http://www.geosig.com) → **Support** → **Downloads**

- When GeoDAS is started for the first time, it will ask to add stations in its configuration.
- Click **Yes**

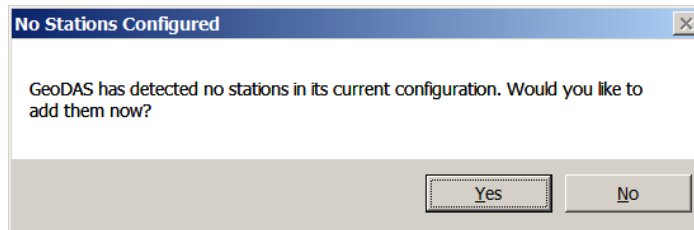



Figure 8: "No stations configured" message at startup of GeoDAS

👉 | If there are already stations configured in GeoDAS, this window will not appear. Please press the wizard button  in the GeoDAS menu

👉 | An exported GeoDAS configuration is in the USB stick that gets shipped with the instrument

### 5.4 Adding New Stations ...

👉 | Make sure the computer is connected to the same network as the instrument and in the same IP range.

- In the following window, select **My instrument other than GSR is connected to the local network** and press **Next >**

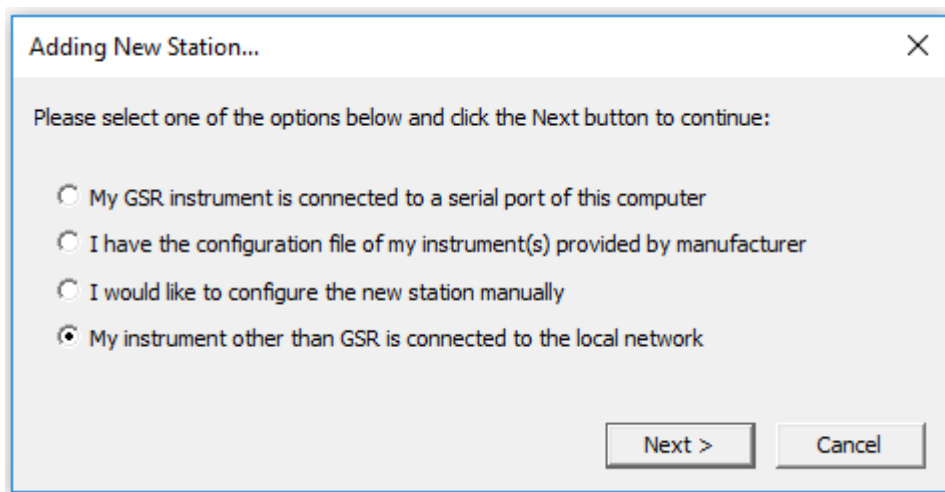

Figure 9: Instrument wizard

- Enter the **Serial number** of the instrument and press **Login >**. It is also possible to add more than one station by entering only a fragment of the serial number which is similar on all instruments. For example if there are the serial numbers 100210, 100211 and 100234. By entering '1002' all the stations will be added. By putting '10021' just the stations 100210, 100211 will be added.

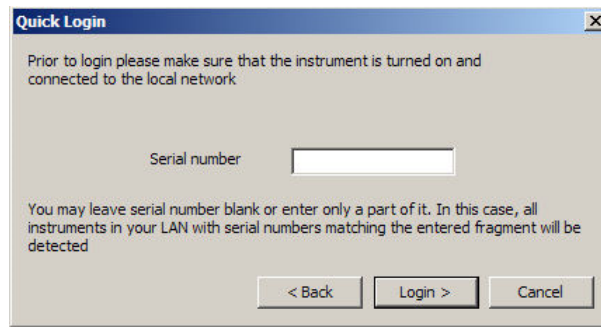

Figure 10: Quick Login Window

- All the found stations will be listed, press **Finish** to add them to GeoDAS

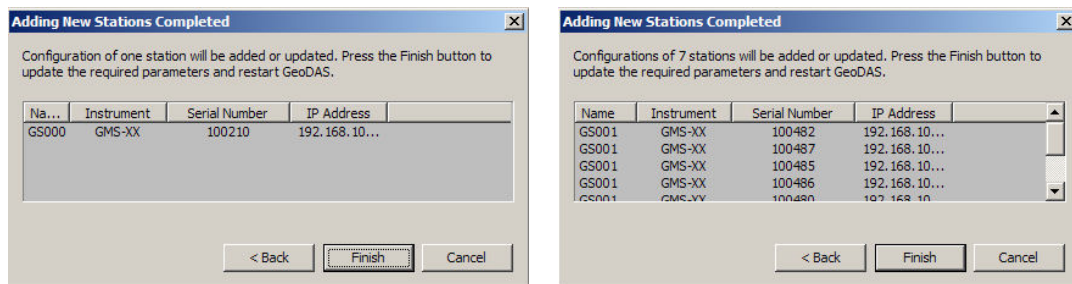

Figure 11: List of all stations found - single station left, multi-selection right side

## 5.5 Configuration of Data Server

- Proceed to the menu **Settings** → **Configure Stations ...**
- The following window will appear where all the instruments are listed in the area 1. To add stations make a right click and choose **Add Station to current configuration**. Please see chapter C.1 for details.

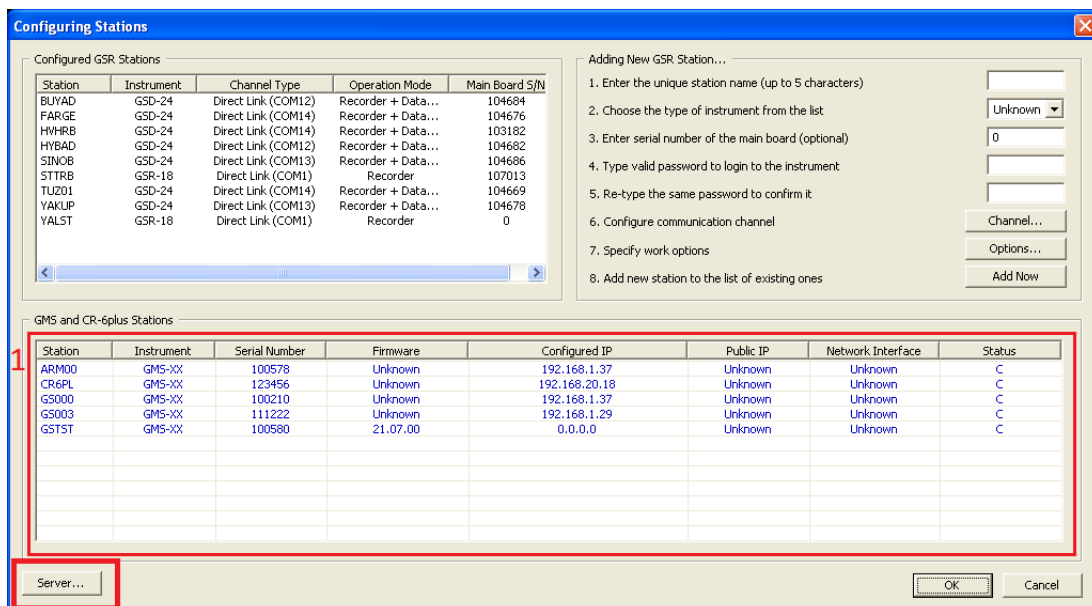

Figure 12: Configuration and overview of the stations

- Press the button **Server...** When the window below appears, enter the following data:
  - **My server IP address**            **IP of your computer**
  - **Server port**                         Select a user defined port, use **3456** by default

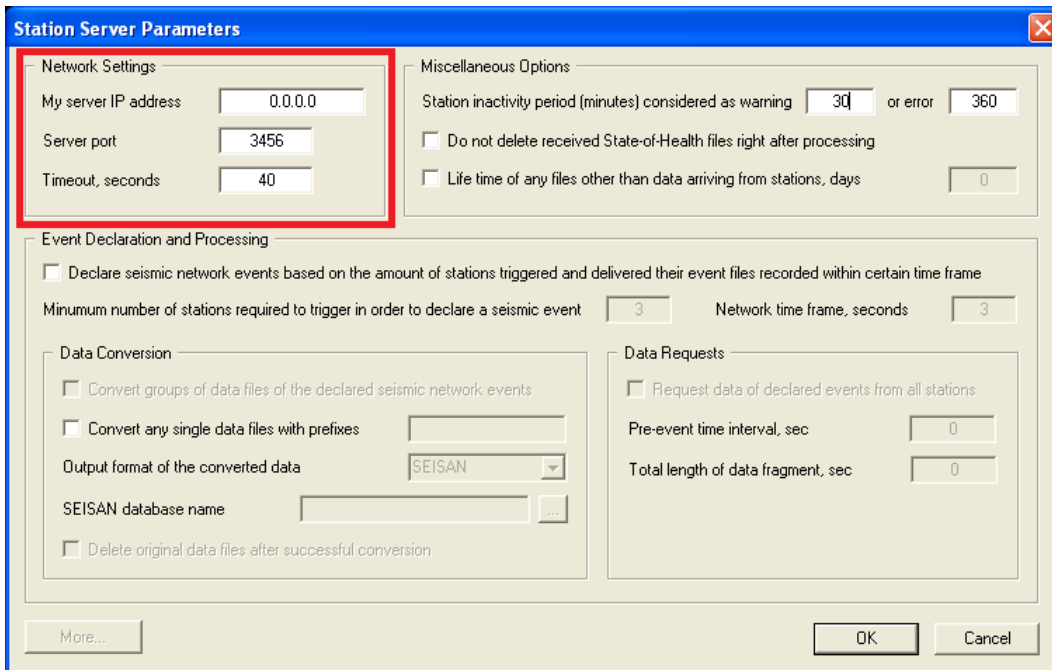

Figure 13: Data server parameter



*In most cases you do not need to enter an IP address. It may only be needed if your computer has several network cards, and you would like to communicate to instruments connected only to one subnetwork. Otherwise you may leave the default zero IP address 0.0.0.0*

*If you don't know how to find out your IP address, follow these steps:*

- Click **Start** → **Run** → type **cmd**, then press **OK**

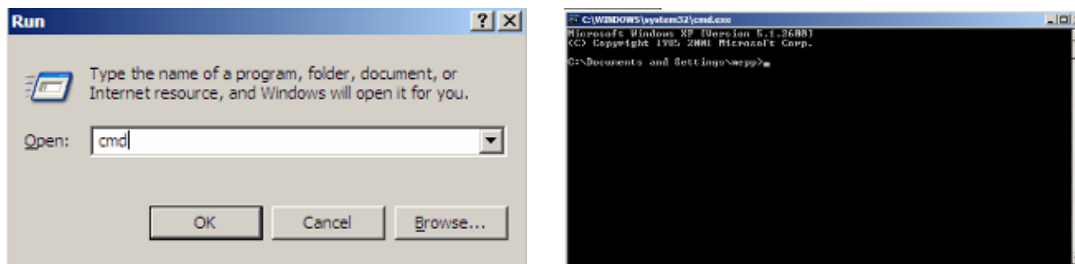

- Enter the command **'ipconfig'**, then your IP appears

```
Ethernet adapter Local Area Connection:
    Connection-specific DNS Suffix . :
    IP Address . . . . . : 192.168.10.107
    Subnet Mask . . . . . : 255.255.255.0
    Default Gateway . . . . . : 192.168.10.254
```

- Type **exit**

- Write down the IP and port you have configured
- Press **OK** two times to exit again to the main window of GeoDAS



## 5.6 Basic Configuration of the Instrument

- In the window Stations: General Information make a **right click** on the station name and select **Instrument Setup...**

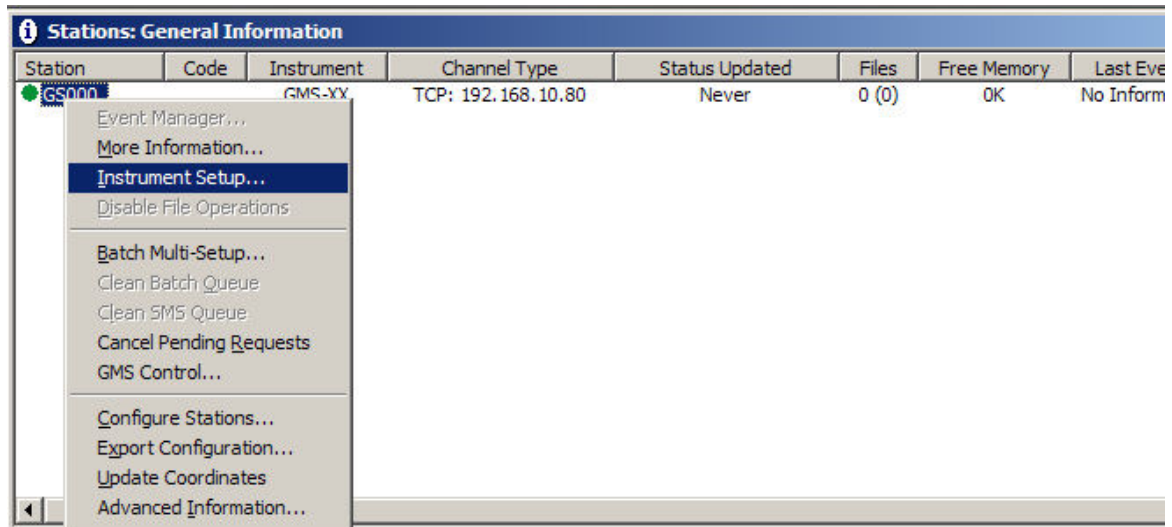

Figure 14: Instrument setup

- A window showing the Web Interface will appear.



Figure 15: Web Interface of the selected instrument

- To be able to adjust the configuration of the instrument it is required to authenticate oneself to the device. The default login credentials are: Username: **admin**, password: **123456**. Then press **login**

- Go to **Configuration** → **Communication Parameters**.

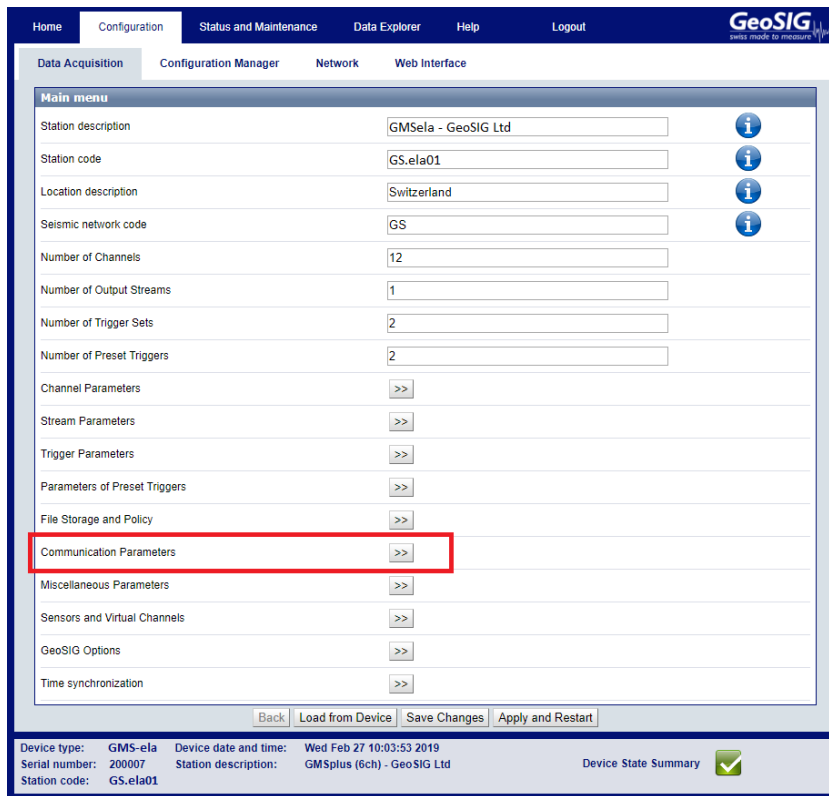

Figure 16: Communication parameters

- Tick the flag **Contact Remote Servers** to configure a connection to a remote server.
- Go to **Server Parameters**

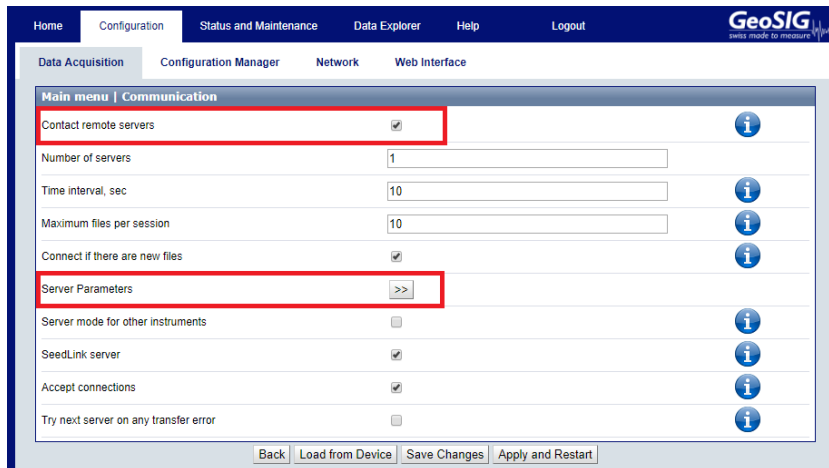

Figure 17: Edit Communication parameters

- Configure the **Server IP address** and press. The default *Server port* is **3456** and should be kept.
- Then press **Save and Restart**.

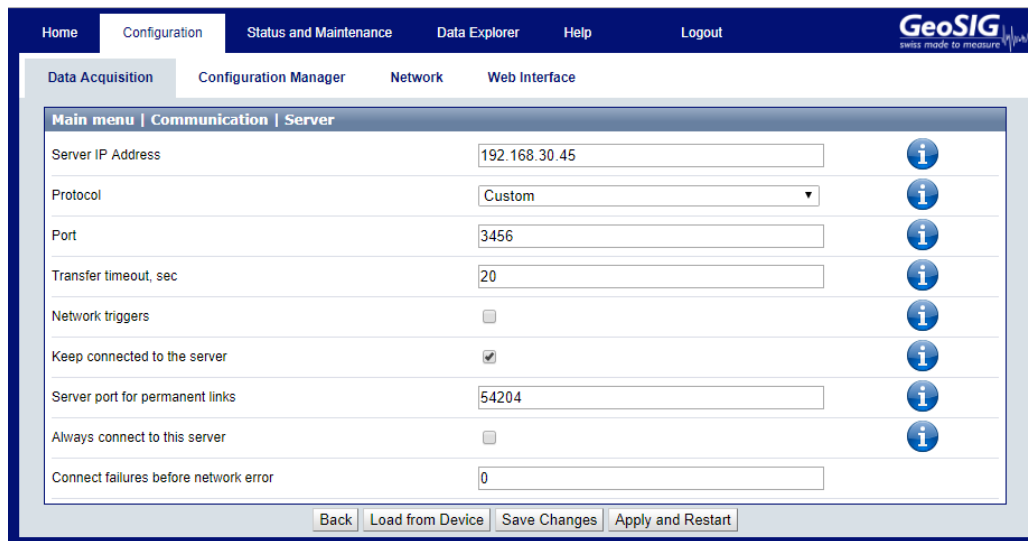

Figure 18: Edit Server parameters

- Under *Protocol*, select **Custom** and add the default *Port*: **3456**.
- Then press **Apply and Restart**.
- After the instrument has restarted it is ready for operation and can be configured according to chapters 8 and 9.

## 6 Principle of Operation of the Instrument

This chapter gives an overview of the normal operation of the instrument in a network or as a standalone unit.

### 6.1 Normal Operation

During normal operation the instruments are installed on sites and connected to a data server over Ethernet or Internet. The instrument checks in a defined interval whether there are any requests or firmware updates ready for pick up on the server. Additionally - and if configured - the instrument uploads the ringbuffer files (from continuous recording) and the state of health files to the data server.

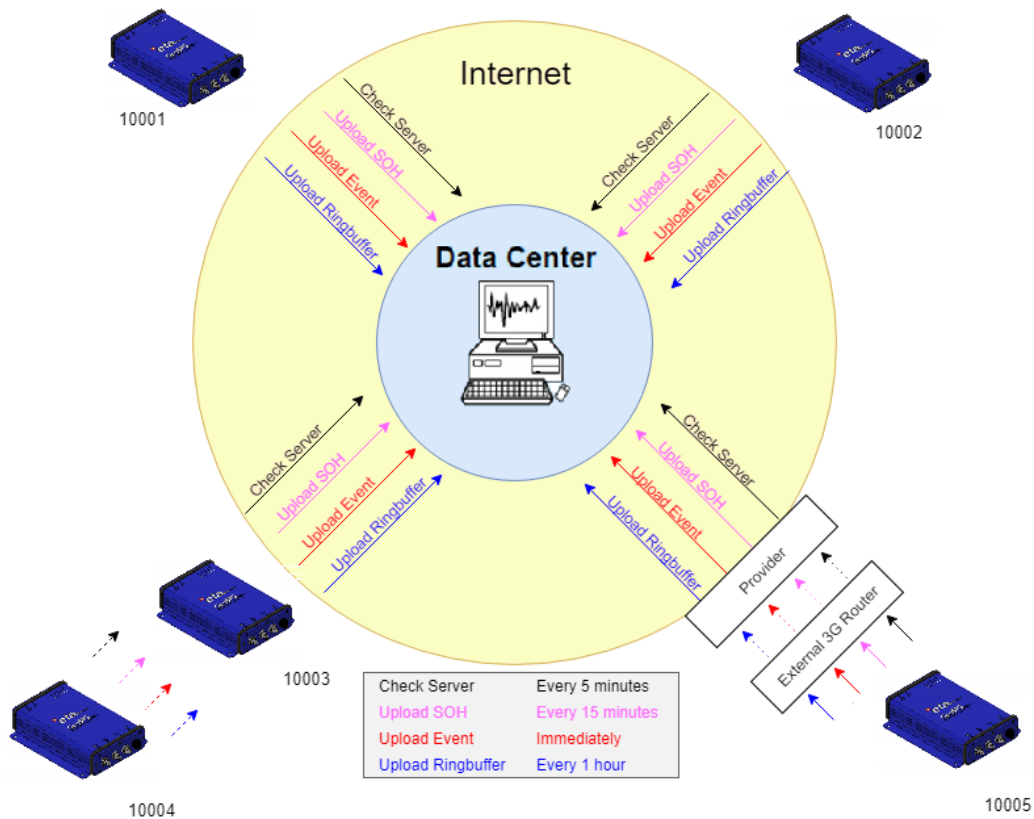

Figure 19: Normal operation in a network

## 6.2 Behaviour on a Seismic Event

In the event of an earthquake with vibrations above the trigger threshold, the instrument will record the event and immediately upload it to the data server (see Figure 20). In case some of the stations are too far away from the epicentre to trigger, the data can still be collected from all instruments:

- A data request will be placed on the server
- All instruments will download the request during the next time checking the server (see Figure 21)

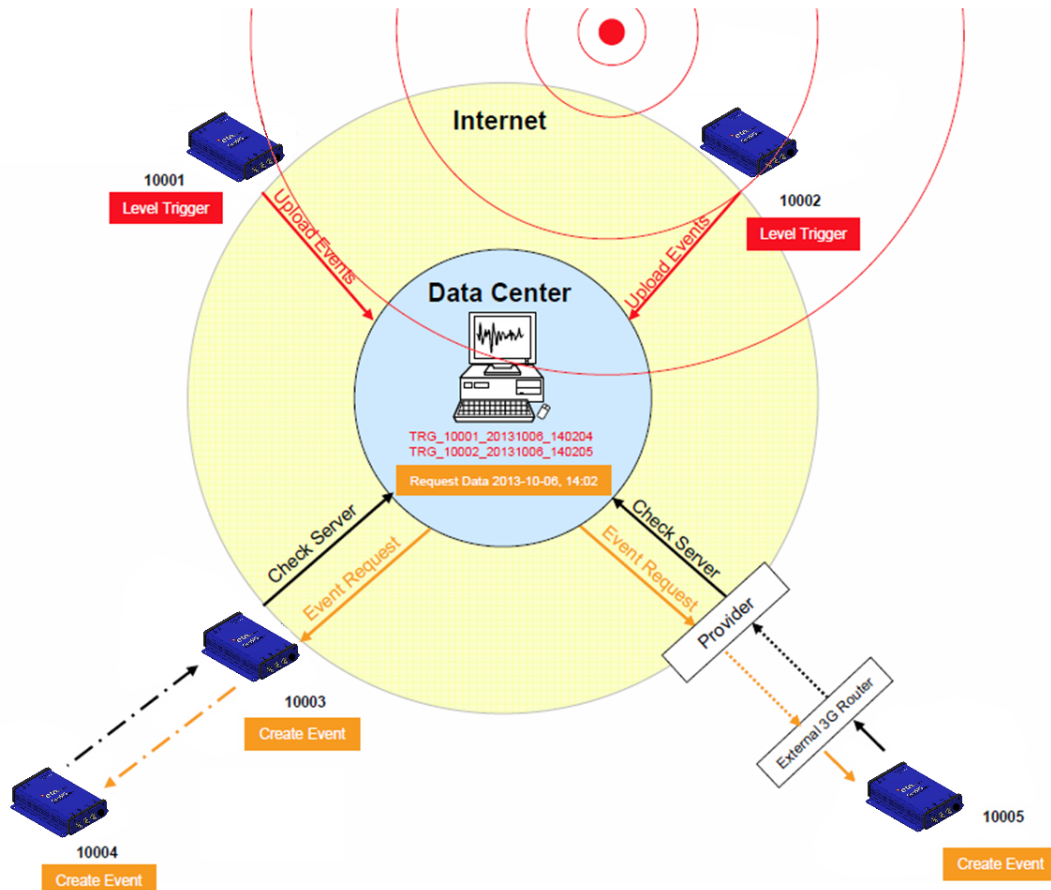

Figure 20: Upload of seismic events and download of requests from the server

- All instruments will create an event at the time listed inside the data request and extract these data out of the ringbuffer data.

- The extracted event file will be uploaded to the data server (see Figure 21)

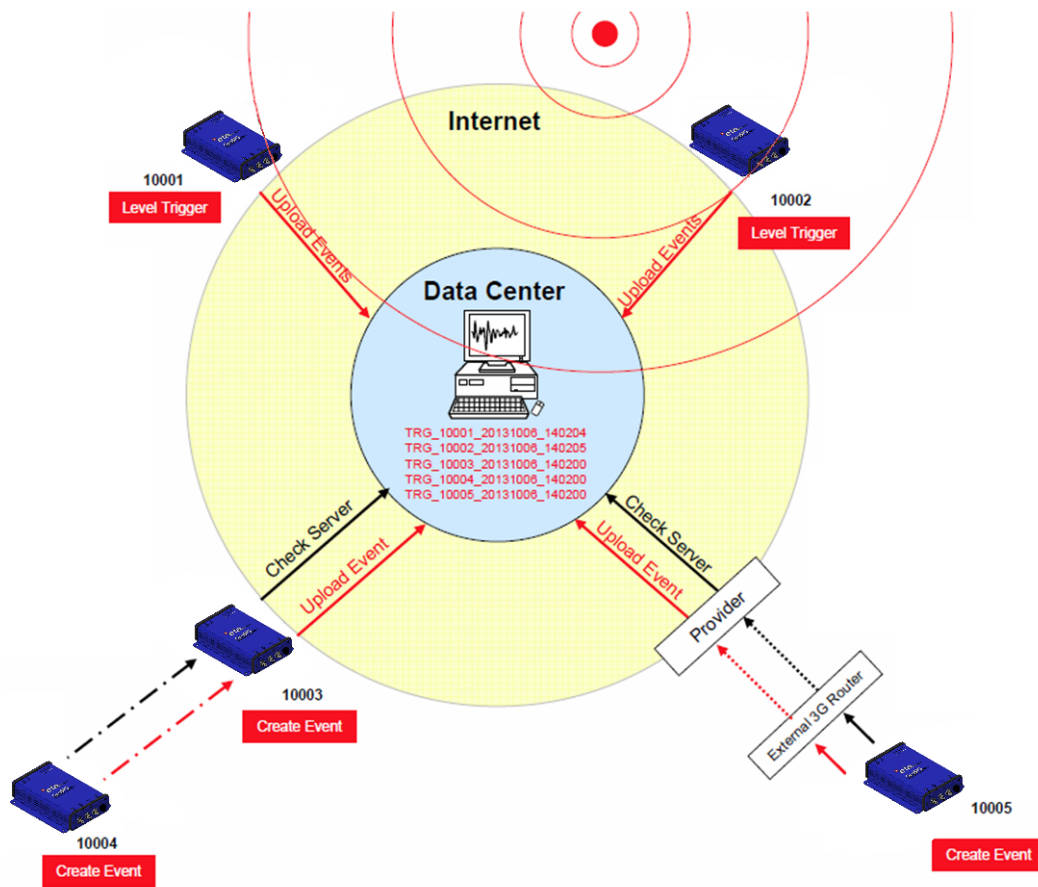

Figure 21: Behaviour on Events: Upload of extracted events

### 6.3 Firmware and Configuration Upgrade

In case of a firmware upgrade, the new firmwares can be easily put on the server. All instruments will recognise the new firmware during the next server checkup, download and install it. See chapter 11 for details about the firmware upgrade. The same happens also with new configurations. In case the option "Keep connection to the server" is enabled under Server Parameters (see chapter 9.8 for details), then the instrument will keep the channel open so that it is possible to configure the instrument via the Web Interface without knowing the IP address of the instrument. See chapter 8 for details.

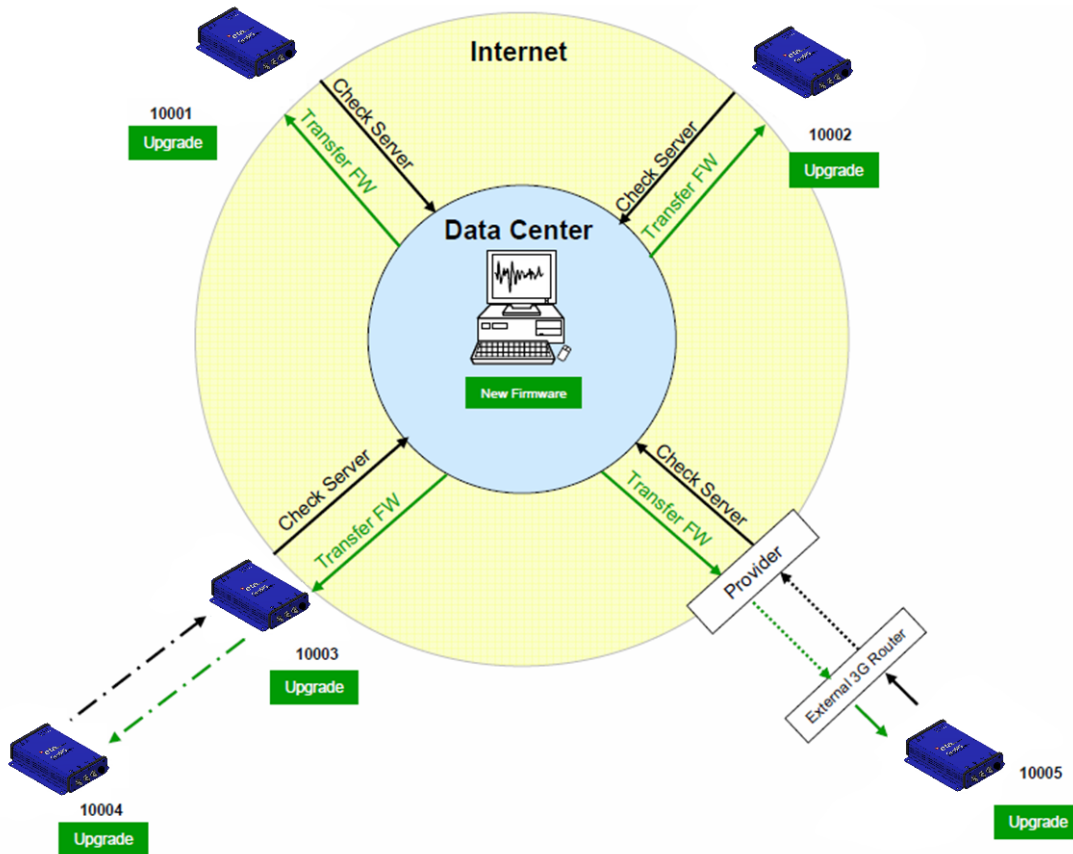

Figure 22: Firmware upgrade

## 6.4 Backup Server

It might be that the instrument is not able to contact the main data server anymore: either because it is down or a wrong server has been configured. For example, this can happen if a configuration file with wrong server settings is uploaded accidentally to an instrument. In this case the instrument will contact the backup server that has been configured in the test and configuration menu. Therefore the configuration of the backup server is very important and should not be ignored. For more information how to set the backup server see chapter 5.2.

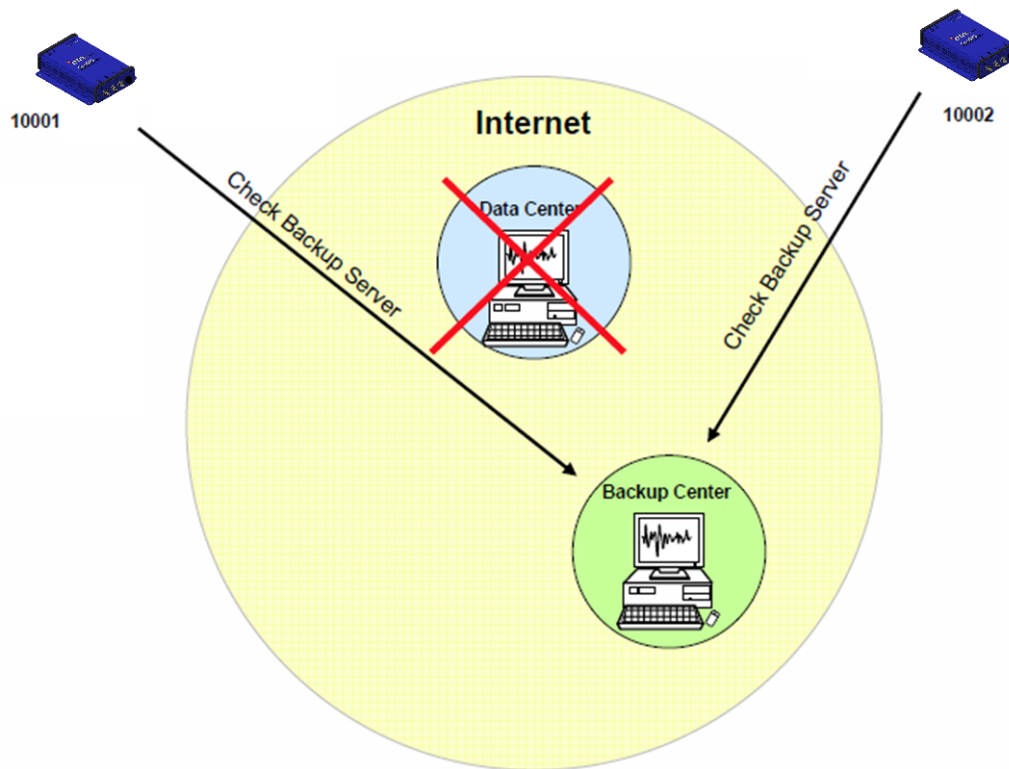

Figure 23: Connection to backup server in case connection to main server fails



## 7 Network Settings

The network configuration is the same whether using a wired network or wireless network. The specific settings related to the wireless network configuration via the local console are described in chapter 7.4.

### 7.1 Network Settings through the Web Interface

- To open the Web Interface please do one of the following two steps:
  - In the window *Stations: General Information of GeoDAS* make a **right click** on the station name and click on **Instrument Setup...** or
  - Open your browser and enter the IP address of the instrument (see chapter 7.5 for details) in the address bar of your browser.
- To be able to adjust the configuration of the instrument it is required to authenticate oneself to the device. The default login credentials are: Username: **admin**, password: **123456**
- Go to the tab **Configuration** → **Network Configuration**. The following screen can be seen (pictured below).
- Adjust the wired Ethernet settings under *eth0*. In case the instrument has a second wireless Wi-Fi interface, then additionally available Wi-Fi networks can be scanned or all parameters can be manually adjusted.
- Click **Save Network Configuration to Device**.

Home
Configuration
Status and Maintenance
Data Explorer
Help
Logout

Data Acquisition
Configuration Manager
Network
Web Interface

**Network Interface Information**

**eth0**

**Current Configuration (eth0)**

<b>Name</b>	<b>Active Configuration</b>	eth0 Wired Ethernet
IPv4 Address	192.168.30.176	
IPv4 Netmask	255.255.255.0	
IPv6 Address	fe80::8e8e:76ff:fe00:3e7a	
IPv6 Netmask	ffff:ffff:ffff:ffff::	
Interface Type	Broadcast	
Interface is Active	Yes	
Loopback Interface	No	
MAC Address	8C:8E:76:00:3E:7A	

**Change Saved Configuration (eth0)**

Interface Type: Wired

Network Configuration: Static

IP Address:

Netmask:

Gateway IP:

Preferred DNS Server:

Alternate DNS Server:

**wlan0**

**Current Configuration (wlan0)**

<b>Name</b>	<b>Active Configuration</b>	wlan0 Wireless Wi-Fi
Access Point/Cell	Not-Associated	
ESSID	GS_Wifi	
Encryption key	off	
Fragment threshold	off	
Frequency	Frequency:2.437 GHz	
IPv4 Address	169.254.32.52	
IPv4 Netmask	255.255.0.0	
Interface Type	Broadcast	
Interface is Active	Yes	
Loopback Interface	No	
MAC Address	00:0D:F0:BF:21:E1	
Mode	Managed	
Power Management	off	
RTS threshold	off	
Retry	long limit:7	
Tx-Power	20 dBm	
Wifi Protocol	IEEE 802.11bgn	

**Change Saved Configuration (wlan0)**

Interface Type: Wifi

Network Configuration: DHCP

**Wifi Parameters**

ESSID:

Wifi Topology: Infrastructure

Encryption: WPA2

**WPA and WPA2 Parameters**

Key Type: Password

Password (8 to 63 Characters):

Reload Network Configuration from Device
Save Network Configuration to Device

Figure 24: Configuration of network interface

## 7.2 Network Settings through GeoDAS

- Under **Settings** click on **Configure Stations...**, the following window appears:

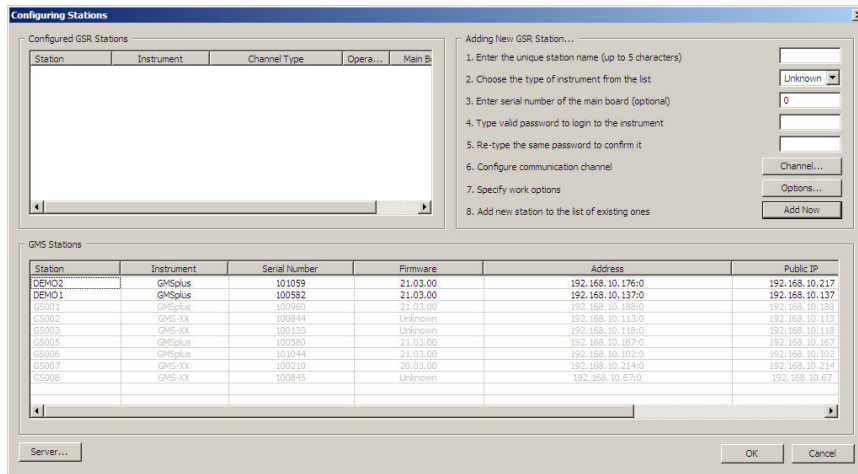

Figure 25: Configuring Stations screen

- Make a **right click** on the station name and choose **Edit Network Settings of Instrument**

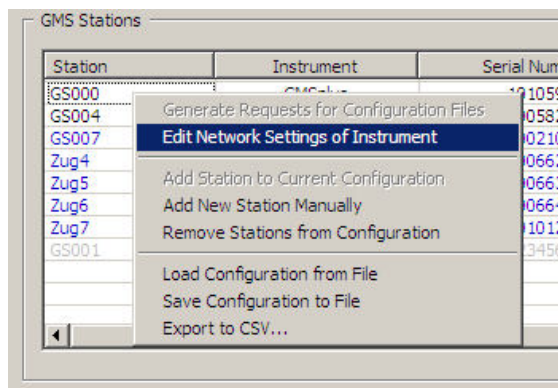

Figure 26: Edit Network settings

- Adjust all the network parameters in the following screen wherein the **Primary Network interface** is the wired Ethernet, and Embedded Wi-Fi interface is the wireless network interface.

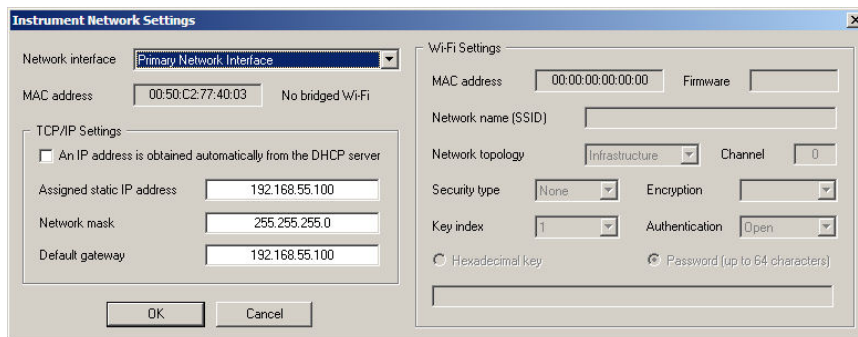

Figure 27: Configuration of wired Ethernet

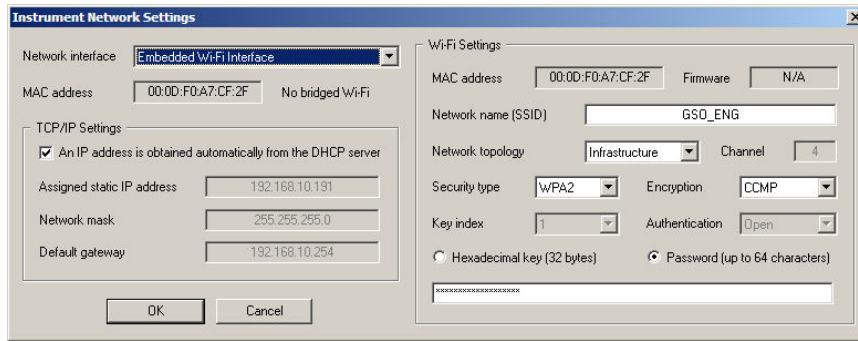

Figure 28: Configuration of wired Ethernet

### 7.3 Wired Ethernet settings through the local Console

Please see chapter 5.2 for details.

### 7.4 Wireless Settings through the local Console

- Switch on the instrument by pressing and holding the POWER button for 2 seconds.
- Press **'Ctrl + Z'** as soon the following message appears on the console to enter the test mode.

```
#####
##### Test and Initial Configuration Mode #####
#####
Press Ctrl+Z to enter the test mode.....
```

The following menu will appear (see chapter 10 for details):

Level	Shortcut	Password	Description
User	Ctrl+U	None	Basic operations only
Powerful User	Ctrl+W	None	Also hardware options and pre-selected tests
Administrator	Ctrl+A	None	Also manual tests and altering the FLASH memory content

Your level [U/W/A] or press B to boot now:

- By default, no passwords are set, so press **'U'** to enter the User Mode, and then **'N'** to enter the menu Network settings and proceed until the following menu appears:

```
---- Wireless network interface ----
Static IP address (1=YES, 0=AUTO)?
```

- Select if the instrument should have a static or a dynamic IP address by pressing **'1'** (Static) or **'0'** (Dynamic). If a dynamic IP address is chosen, a DHCP server must be available in the network to provide the IP address settings.
- If a static IP address is selected, an additional message will appear asking for the *Instrument IP address*, *Instrument network mask* and *Instrument gateway IP address*. If you don't know these parameters please ask your network administrator.
- By pressing **'E'** the instrument scans the available networks and lists them. Choose the network to connect by pressing the **number** next to the network SSID or press **'C'** to configure the network settings manually.

```
Scanning wireless networks.
-----
  N   Network SSID           Mode           Encryption   Channel   Level,%
-----
  1   GSO_ENG                Infrastructure   WPA2         1         81
-----
Enter the number of a network above, <S>can again or <C>onfigure manually:
```

- If the network is encrypted, please enter the network key.

```
Passphrase (8-63 ASCII) or a 64-character hex key (ad43Fd2d22):
```

- Adjust the other parameters concerning the SSH or recovery server if required.
- When the instrument tries to connect to the network, this can take a while. Please be patient until the following menu appears again:

```
Access level: User

--- Flash Images and Boot Options ---
L - List flash images
Q - Reset instrument configuration to the user default
V - Reset instrument configuration to the factory default
5 - Boot now
X - Reboot the instrument
Y - Power off

--- Hardware Setup and Monitor ---
N - Network settings

--- Security ---
0 - Set password

-->
```

- Press **'5'** to continue the boot process of the instrument.

## 7.5 Get IP from Instrument

- To get the IP from the instrument please press **'I'** in the main menu to access the *System information* menu.

```
Main menu:  
C - Configuration ->  
M - Messages ->  
X - Display errors (0) and warnings (0)  
W - Clear errors and warnings  
T - File statistics  
I - System information ->  
S - Shell command  
U - Control requests ->  
R - Restart firmware  
Z - Reboot instrument  
Q - Quit
```

- Press **'L'** to view the *Network information*

```
System information:  
View alarm status  
B - View RTC status  
C - View SUP information  
D - View DSP information  
E - View NTP status  
View DSA status  
View GPS information  
View wireless sensors  
I - List firmware images  
J - View firmware container information  
K - View constant parameters  
L - View thread list  
M - View trim values  
N - View network information  
R - View relay information
```

- Please see the IPs of the wired Ethernet (*eth0*) and the wireless Ethernet (*wlan0*) listed and marked here in red.

```
Network interfaces:
eth0    Link encap:Ethernet  HWaddr 00:50:C2:77:42:8E
        inet addr:192.168.10.133  Bcast:192.168.10.255  Mask:255.255.255.0
        inet6 addr: fe80::250:c2ff:fe77:428e/64 Scope:Link
        UP BROADCAST RUNNING MULTICAST  MTU:1500  Metric:1
        RX packets:71 errors:0 dropped:1 overruns:0 frame:0
        TX packets:16 errors:0 dropped:0 overruns:0 carrier:0
        collisions:0 txqueuelen:1000
        RX bytes:6538 (6.3 KiB)  TX bytes:1678 (1.6 KiB)
        Interrupt:21 Base address:0x4000

lo      Link encap:Local Loopback
        inet addr:127.0.0.1  Mask:255.0.0.0
        inet6 addr: ::1/128 Scope:Host
        UP LOOPBACK RUNNING  MTU:16436  Metric:1
        RX packets:3 errors:0 dropped:0 overruns:0 frame:0
        TX packets:3 errors:0 dropped:0 overruns:0 carrier:0
        collisions:0 txqueuelen:0
        RX bytes:172 (172.0 B)  TX bytes:172 (172.0 B)

wlan0   Link encap:Ethernet  HWaddr 00:0D:F0:8E:05:DF
        inet addr:192.168.10.94  Bcast:192.168.10.255  Mask:255.255.255.0
        inet6 addr: fe80::20d:f0ff:fe8e:5df/64 Scope:Link
        UP BROADCAST RUNNING MULTICAST  MTU:1500  Metric:1
        RX packets:2333 errors:0 dropped:95 overruns:0 frame:0
        TX packets:636 errors:0 dropped:0 overruns:0 carrier:0
        collisions:0 txqueuelen:1000
        RX bytes:271699 (265.3 KiB)  TX bytes:737148 (719.8 KiB)
```

## 8 The Web Interface

The instrument can be configured over a Web Interface. To be able to use the Web Interface, it is necessary that the following criteria are fulfilled:

- The IP address of the device has to be known (see chapter 7.5) or the flag *Keep connection to the server* under *Server Parameters* (see chapter 9.8 for details) must be enabled (set to Yes).
- In case the flag *Keep connection to the server* is disabled, the port 80 of the device has to be accessible, from the accessing computer. This usually means that the instrument is in the same network as the accessing computer and no firewall mechanism separates the two.
- A current browser version has to be available on the accessing computer.

### 8.1 Accessing the Web Interface

- To access the instrument please follow one of the following two steps.
  - In the window *Stations: General Information* of GeoDAS make a right click on the station name and click on **Instrument Setup...**, as can be seen previously in Figure 14, or
  - Open your browser and enter the IP-Address (e.g. 192.168.30.176) of the device in the address bar of your browser.



Figure 29: The login screen of the instrument at 192.168.30.176

To be able to adjust the configuration of the instrument or access its data, it is required to authenticate oneself to the device. This can be done by entering a valid username and corresponding password in the fields of the same name and pressing the "login" button.

The default login credentials are:

- Username: admin
- Password: 123456

The default password can be changed as described in the chapter 8.3.4 of this manual.



*The Web Interface can be disabled under Network settings in the Administrator mode of the test and configuration menu. See chapter 10 for details.*



## 8.2 The Home Panel and the General Navigation

After the login process has ended, the screen shown in Figure 30 becomes visible. The width of the Web Interface is optimised for a screen width of 1024 pixels. If the width of the browser window is smaller than that, it might be necessary to scroll horizontally.



Figure 30: The home panel of the web interface

As can be seen in Figure 30, each screen in the web interface is separated into three sections:

1. **The Navigation Bar:** The navigation bar allows accessing all screens within the web interface. The navigation bar is further separated into two parts. The top bar is the primary navigation panel which is visible from all screens. The currently active tab is marked white, while all other – inactive – tabs are blue. By changing from one tab to another, the secondary navigation panel becomes active. This secondary navigation tab allows to switch between the actual screens within a primary navigation bar.
2. **The Content Section:** This section will contain all information and configuration options. Most interaction will take place in this part.
3. **The Device State Summary:** On the left side the Station Description and Serial Number is displayed to identify the current instrument you are working on. On the right side the device state summary describes the overall status of the instrument. The states that are possible are listed in Table 2. By clicking on the overall state, information on the actual problems will be displayed. More detailed information on the error states are provided in the menu item "State of Health" as described in chapter 8.4.



Symbol	Meaning	Description
	No errors or warnings reported from the device.	As there seem to be no issues, no action is required.
	A warning is reported from the device	There seems to be an issue in this module. Although it seems not to be critical, it is recommended to check why this warning is displayed and take actions to resolve it.
	A error is reported from the device	An error has occurred and it is required to check for the cause of the problem and resolve it in order to avoid limited functionality.

Table 2: The overall error states shown in the Web Interface

### 8.3 Device Configuration

The configuration screen of the Web Interface gives access to all configuration options, the configuration management of the Data Acquisition Software as well as the Network Configuration and the Web Interface itself.

Loading the configuration can take a few seconds. During this time at the right corner of the browser **Loading...** is displayed. Please be patient till the screen shown in Figure 31 appears.

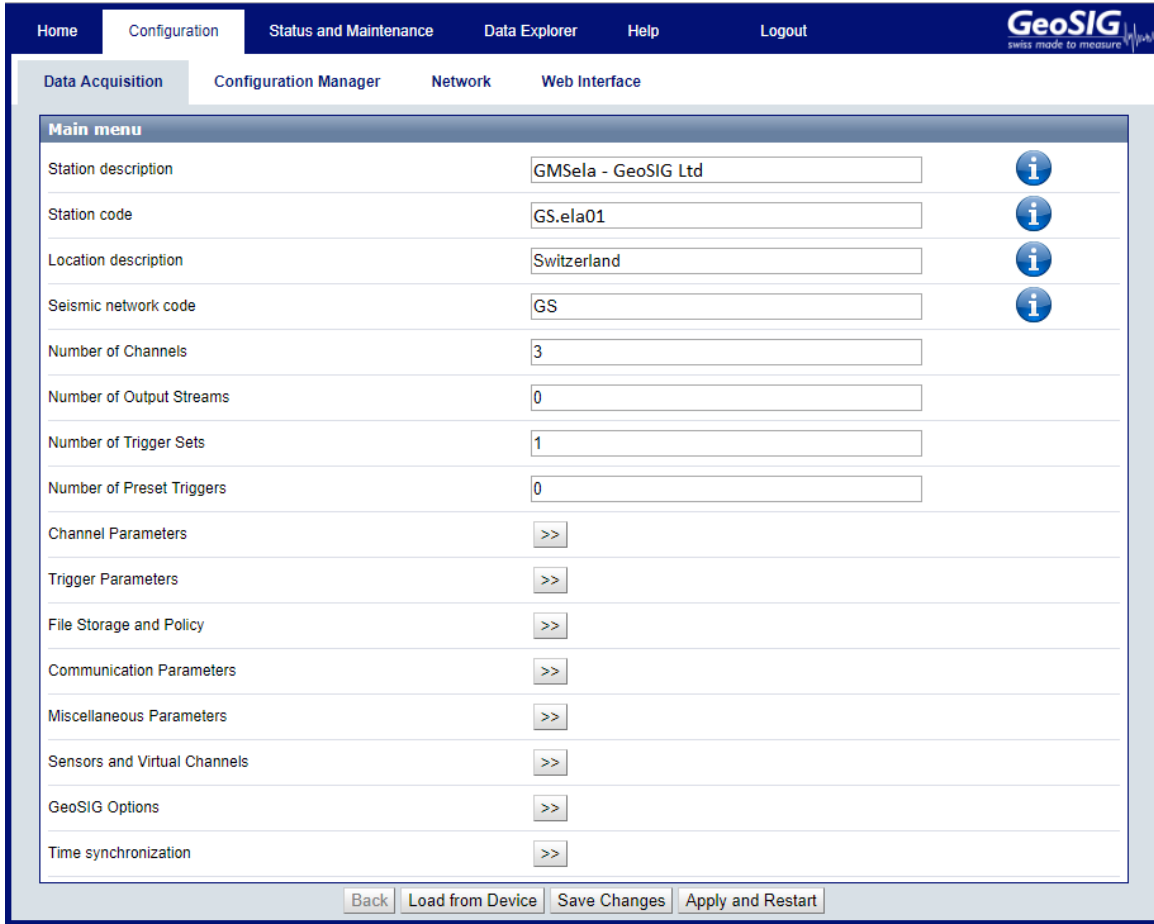
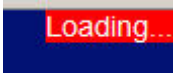

Figure 31: Configuration main menu

### 8.3.1 Data Acquisition Configuration

The **Data Acquisition** sub menu provides access to the data of the current configuration of the data acquisition software. As depicted in Figure 32, the content of this tab is divided into two sections:

1. **The Configuration Panel:** This is main part of the armdas Configuration screen. Within this part of the screen all the values of the configuration of the selected Configuration Menu Item can be adjusted. Most options will provide a help button in the form of white question mark on blue ground on the right part of this section. By clicking on it information will be displayed over the option. Please note that the only way to restore the original values of the fields after making changes to them is by using the "Load from Device" Button in the Action Panel.
2. **The Action Panel:** This panel is providing the option to either reload the current configuration from the device (to discard changes or load changes done by another user) or to save the edited configuration to the device or to save the edited configuration to the device and restart the data acquisition software. Saving and restarting will interrupt the current recording for about 20 seconds. During this time triggers will not be executed either. Please note that if the device is configured to use a DHCP server, the address might change during the saving of the configuration which will make the web interface inaccessible under the old address.

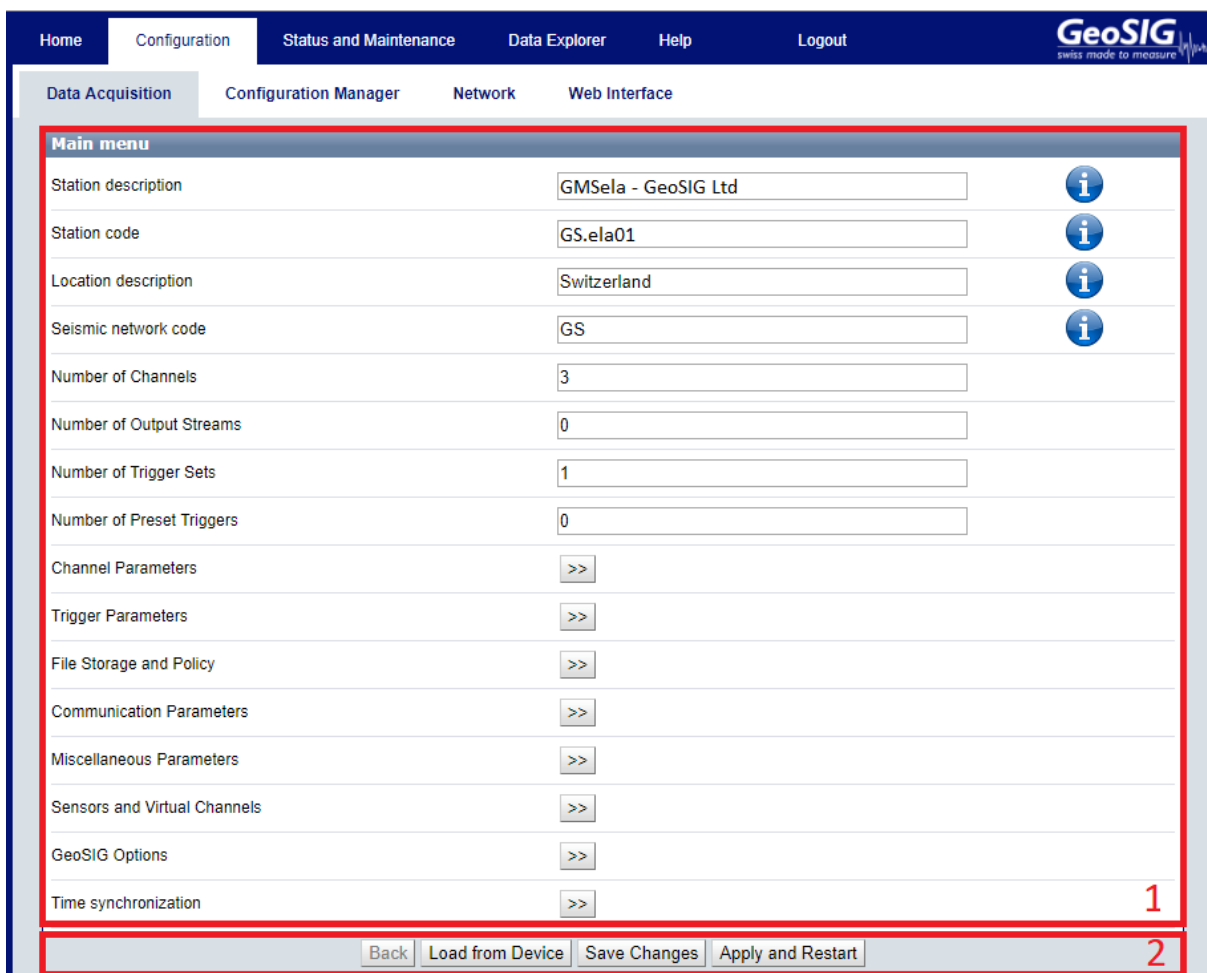

Figure 32: Configuration panels

### 8.3.2 Configuration Manager

As described in the previous chapter, the *Data Acquisition* screen only allows configuring the currently used configuration. The **Configuration Manager** screen described in this chapter allows managing several configurations, changing the current configuration, uploading a new configuration and so on. As depicted in Figure 33, the screen is divided into three sections:

1. **The Configuration List:** This list contains all configurations currently available on the main storage media. The *Current Configuration* is always listed here. This configuration can be copied and downloaded but not renamed, removed or made the current configuration (as it is already the current). As depicted in Figure 33, these options become available to other configurations stored on the device (in this example after uploading a file to the device). When pressing **Use as Current Configuration** it will store this configuration as the *Current Configuration*. The existing configuration will be overwritten and the instrument restarted. Note that only the *Current Configuration* can be edited in the *Firmware* screen. The other configuration files will remain untouched. The *Current Configuration* can be saved in a file by pressing **Copy**.
2. **User Default Panel:** With the **Reset To Default**, the *Current Configuration* will be overwritten by the user default (see command SETDEF CFG in the chapter 9.12.1) and the instrument will be restarted. The *Current Configuration* can be saved as the user default by pressing the button **Make Current**

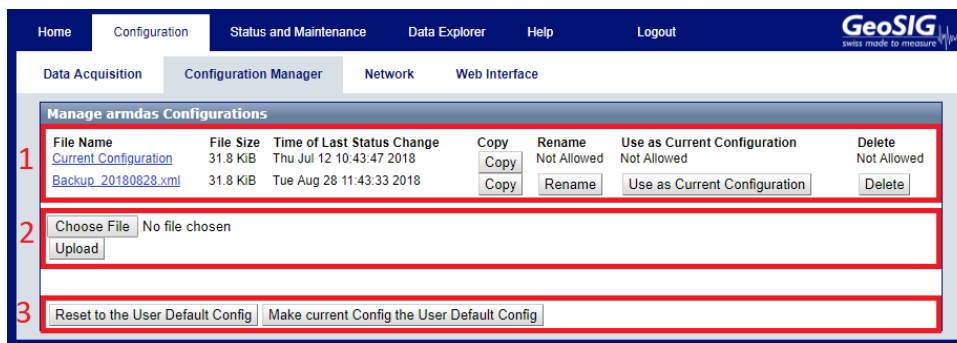

Figure 33: Configuration Manager screen

3. **The Upload Panel:** While the *Configuration List* allows downloading configurations from the device by clicking on the name, this part of the screen provides the possibility to upload a configuration to the web interface by selecting a configuration file and using the **Upload Configuration** Button. As can be seen in Figure 34, after a successful upload a new file is shown in the Configuration List and the name of the newly available configuration is written at the top of the list. (The name of new configuration will be created from a random string followed by "\_config.xml"). The configuration can then be changed by clicking on **Rename**. Note that the upload panel might look different depending on the browser in use.

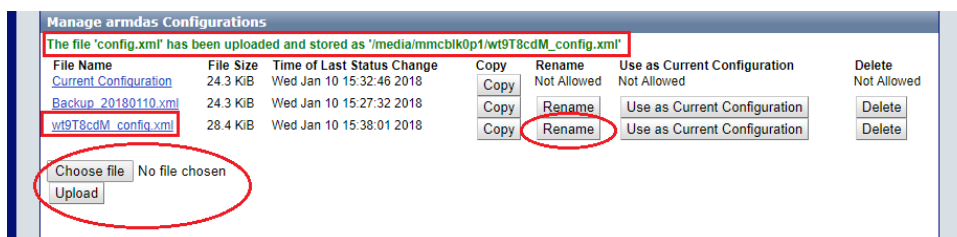

Figure 34: Choose new file to upload

To upload a file, click on **Choose File** and select the configuration file to upload.

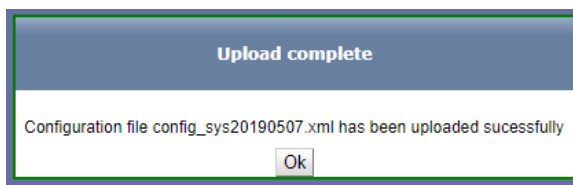

Figure 35: Configuration file is now uploaded

In figure 35, click on **OK** to finalize the upload.

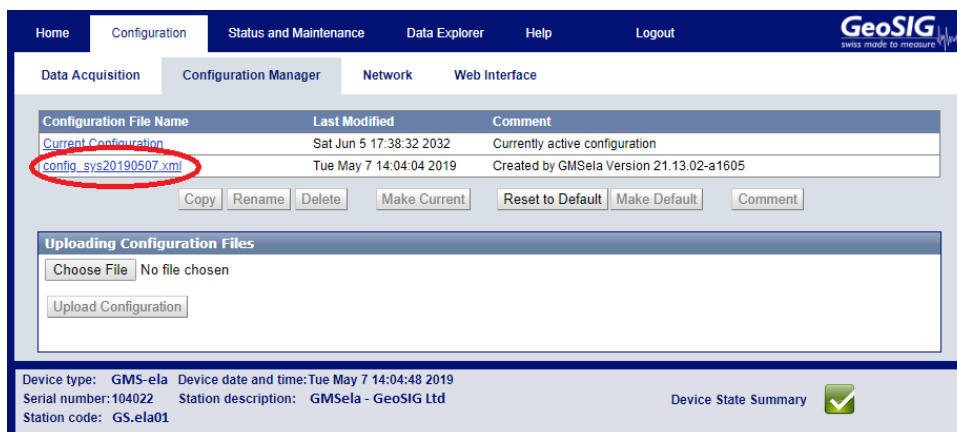

Figure 36: File is uploaded

The red circle in the figure 36 shows the configuration file which was uploaded.

### 8.3.3 Network Configuration

#### 8.3.3.1 Wired Ethernet

The *Network Configuration* screen provides the possibility to change the network configuration of all network interfaces of the instrument. For the standard instrument only one network interface is available: the Ethernet interface, which is present in all devices. (This interface is marked as "ETHERNET" in Figure ). This interface can be configured in the section of the screen that is marked with the red number "1" in Figure 37. The top part of that framed, red section describes the current configuration of the interface. The part below allows changing this configuration. The name of this network interface is traditionally **eth0**.

#### 8.3.3.2 Wi-Fi Wireless Ethernet

Some devices contain an additional wireless interface. If this is the case, a second configuration panel is shown in the Network Configuration screen as can be seen Figure 37 (marked with the red number "2"). As with the default Ethernet interface the section surrounded by the red frame is split in two parts, where the top part defines the current settings and the bottom part provides the possibility to change the configuration. Additionally to the standard network settings like IP Address, Netmask, Gateway and so on, the actual wireless settings can be adjusted and open wireless networks scanned. The name of this network interface is traditionally **wlan0**.

Home Configuration Status and Maintenance Data Explorer Help Logout

Data Acquisition Configuration Manager Network Web Interface

### Network Interface Information

**1 eth0**

Current Configuration (eth0)		Active Configuration	eth0 Wired Ethernet
Name			
IPv4 Address		255.255.255.0	
IPv4 Netmask		fe80::8e8e:76ff:fe00:3e7a	
IPv6 Address		ffff:ffff:ffff:ffff::	
IPv6 Netmask		Broadcast	
Interface Type		Yes	
Interface is Active		No	
Loopback Interface		8C:8E:76:00:3E:7A	
MAC Address			

**Change Saved Configuration (eth0)**

Interface Type: Wired

Network Configuration: DHCP

**2 wlan0**

Current Configuration (wlan0)		Active Configuration	wlan0 Wireless Wi-Fi
Name			
Access Point/Cell		GS_Wifi	
ESSID		off	
Encryption key		off	
Fragment threshold		off	
Frequency		Frequency:2.437 GHz	
IPv4 Address		169.254.32.52	
IPv4 Netmask		255.255.0.0	
Interface Type		Broadcast	
Interface is Active		Yes	
Loopback Interface		No	
MAC Address		00:0D:F0:BF:21:E1	
Mode		Managed	
Power Management		off	
RTS threshold		off	
Retry		long limit:7	
Tx-Power		20 dBm	
Wifi Protocol		IEEE 802.11bgn	

**Change Saved Configuration (wlan0)**

Interface Type: Wifi

Network Configuration: DHCP

**Wifi Parameters**

Search Open Wireless Networks

ESSID: GS\_Wifi

Wifi Topology: Infrastructure

Encryption: WPA2

**WPA and WPA2 Parameters**

Key Type: Password

Password (8 to 63 Characters): \*\*\*\*\*

Reload Network Configuration from Device Save Network Configuration to Device

Figure 37: Network Configuration Screen

### 8.3.4 Web Interface Configuration

The *Web Interface Configuration* screen allows configuring all settings related to the Web Interface. At the moment, this solely consists of the possibility of changing the password for the login. To change the password press **Change**. The current password has to be known.

The default login credentials are:

- Username: admin
- Password: 123456

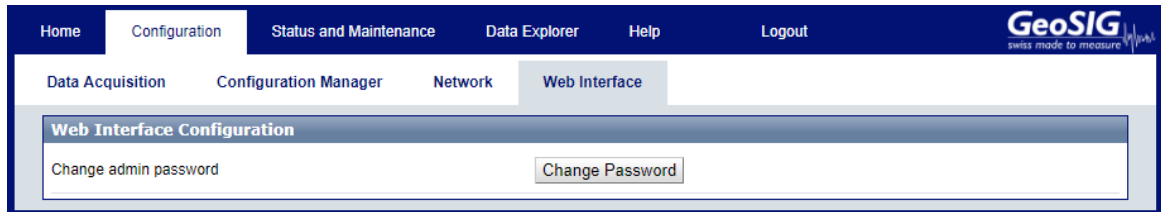

Figure 38: Web Interface Configuration Screen

## 8.4 State of Health

The State of Health (SOH) menu item provides all information related to the error status of the device as well as the status of the available hardware and software versions.

### 8.4.1 Error Status

As depicted in Figure 39, this screen provides basic information about the device (area 2) as well as the error status for each module (area 3). The summary of this SOH information is visible at the bottom of each page as the **Device State Summary**, described in chapter 8.2. Additionally it is possible to download the State of Health information as a file in XML format and clear the errors (area 1).

The screenshot displays the 'Errors and Warnings' section of the GMSela interface. It features a table with two columns of system components, each accompanied by a green checkmark icon indicating a successful status. The components listed include Event Storage, Event Storage Quota, Configuration Parameters, System Calls, File Operations (opening and deleting), Filesystem Requests, Firmware Resources, Memory Allocation, Flash Memory, User Requests, Communication with Servers, Hardware Resources, DSP Status, DSP Buffer, Ringbuffers, File Writing, Network, General State, and File Reading. Each component is associated with a specific system function or status, such as 'Configuration (Non-Critical)', 'File Index', 'General Status (Non-Critical)', 'Time Synchronisation (Non-Critical)', 'Ringbuffer Operations (Non-Critical)', 'Network (Non-Critical)', 'File Transfer (Non-Critical)', 'I2C Bus', 'RTC Status (Non-Critical)', 'Data Processing', 'Alarm Handling', 'Wind Sensor (if any)', 'NTP Synchronisation (Non-Critical)', 'NTP Synchronisation', 'Sensor Offset', 'Message Queue Interface', 'Sensor Status', 'Hardware Status', 'Digital Sensors (if any)', and 'Main Battery (non-critical)'.

Figure 39: Error Status Screen

The modules in area 3 can have one of the states defined in Table 2.



### 8.4.2 Recording Status

This screen provides all information on the recording and time synchronisation status of the device. As depicted in Figure 40, this screen contains information on the number of events, the timing and synchronisation status of the device, as well as information about the GPS quality and the GPS position of the instrument.

Home Configuration **Status and Maintenance** Data Explorer Help Logout

Errors and Warnings **Recording Status** Hardware Software Maintenance

Download SOH Information as File

Recording Status	
Total number of stored event files:	0
Queued Events:	0
Time of Last Detected Event:	Thu Jan 1 00:00:00 1970
Timestamp of the oldest Data:	Tue Apr 16 12:38:11 2019

Synchronisation Status	
Device Synchronises to:	NTP
Synchronisation Status:	Freewheeling
Max. Synchronisation Interval:	0
NTP Synchronisation Failures:	0
Pulse Detected:	True
Source Valid:	False
Autolock Enabled:	True
Last Lock Time:	Tue May 7 12:21:29 2019
Time Elapsed since last lock:	3h
Drift Rate of the Clock, PPS:	0.3
GPS Status:	Unavailable

Device type: GMS-ela Device date and time: Tue May 7 14:04:48 2019  
 Serial number: 104022 Station description: GMSela - GeoSIG Ltd  
 Station code: GS.ela01

Device State Summary

Figure 40: Recording Status Screen

### 8.4.3 Hardware Status

The **Hardware Status** provides such information as uptime, available disk space, the device temperature and so on. Information about the available hardware options in the instrument, such as Alarm Boards, Wi-Fi Modules and Modems can be found in the section **Hardware Configuration Status**.

The screenshot displays the 'Hardware Status' screen within the GeoSIG web application. The interface includes a top navigation bar with 'Home', 'Configuration', 'Status and Maintenance', 'Data Explorer', 'Help', and 'Logout'. Below this, there are sub-tabs for 'Errors and Warnings', 'Recording Status', 'Hardware', 'Software', and 'Maintenance'. A 'Download SOH Information as File' button is located above the main content area.

**Hardware Status**

Linux Uptime at Site Generation:	0 years, 0 months, 1 days, 21 hours, 11 minutes, 39 seconds
Last Reboot Time:	Fri Jun 21 08:51:48 2019
The Reason for the last Shutdown:	upgrade CFG
Time of the last shutdown:	Fri Jun 21 08:51:38 2019
Environment Temperature:	35.70°C
Available Disk Space:	7.15 GiB
Free Disk Space:	6.18 GiB
AC power input:	ON
Current Voltage (V):	15.18
Voltage Limits (V):	Switch-off: 10.72 Switch-on: 12.74
Minimum Measured Voltage (V):	0.00
Battery-1 voltage (V):	13.23
Battery-2 voltage (V):	0.02
Primary DC/DC converter output voltage:	15.23
Input Voltage to the primary DC/DC converter (V):	13.47
Sensor power supply (V):	15.78

**Hardware Configuration Status**

Last Incoming File from Server:	CFG_200007_20190513_133010.xml
Last Configuration Time:	Mon Apr 30 13:49:50 2018
Source of Configuration:	WebGUI version 1.9-r0-61-g9b36
Configuration Type:	Current
Number of Channels:	6
Alarm Board enabled:	NO
Standard Wi-Fi Module enabled:	NO
Sensor Control Module enabled:	NO
Cell Modem available:	None
Configured Recovery Server:	0.0.0.0:19675
Recovery Server Contact Interval:	24
Main Battery Installation Date:	2018-04-30T00:00:00.000+00:00

Figure 41: Hardware Status Screen

### 8.4.4 Software Status

The Software Status screen contains information on the **Software Versions**.

The screenshot shows the GeoSIG web interface. The top navigation bar includes 'Home', 'Configuration', 'Status and Maintenance', 'Data Explorer', 'Help', and 'Logout'. The 'Status and Maintenance' section is active, with sub-tabs for 'Errors and Warnings', 'Recording Status', 'Hardware', 'Software', and 'Maintenance'. The 'Software' sub-tab is selected, showing a 'Download SOH Information as File' button. Below this is a 'Software Versions' table:

Software Versions	
Webinterface Version:	1.9-r14
Firmware Version:	21.13.02-a1605
Operating System Version:	unknown
DSP Version:	128.03.08-a02
Supervisor Version:	90.01.03-a02

Below the table is the 'Software Upgrade' section, which includes a 'Choose File' button (showing 'No file chosen') and an 'Upload Software' button. The footer bar displays device information: 'Device type: GMS-ela', 'Device date and time: Tue May 7 14:04:48 2019', 'Serial number: 104022', 'Station description: GMSela - GeoSIG Ltd', and 'Station code: GS.ela01'. A 'Device State Summary' link is accompanied by a green checkmark icon.

Figure 42: Software Status Screen

The section **Software Upgrade** allows to download firmware directly through the Web Interface.

- Click on **Choose File**, select a firmware to upgrade and click on **Upload Software**.

### 8.4.5 Maintenance

As shown in Figure 43, the Maintenance screen manage the data file, start a trigger, get SOH file and sending signal-related requests to the data acquisition software.

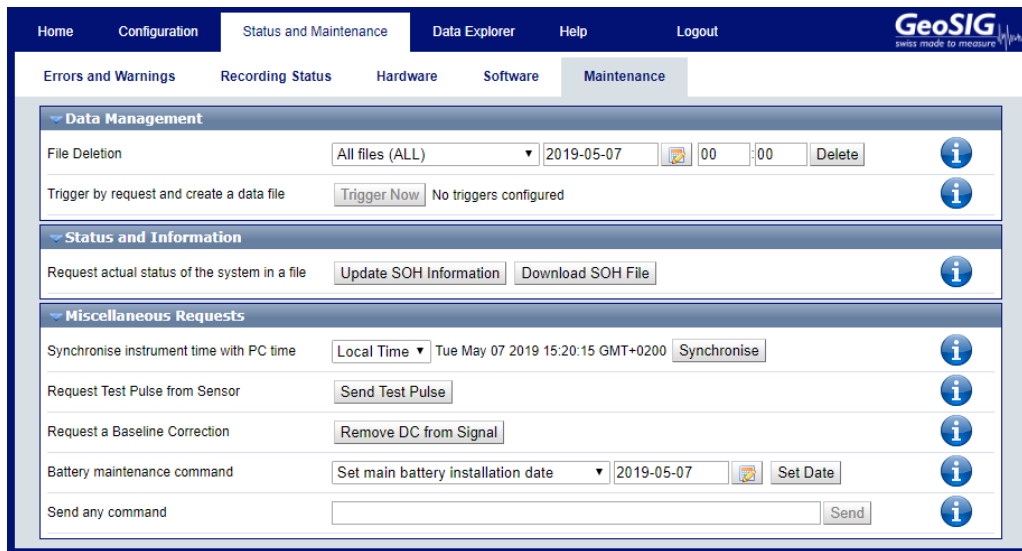

Figure 43: The Maintenance Screen

The **Data Management** section allows to manage the files and start a trigger

- **File deletion** allows to user to delete all or a specific type of file.
- **Trigger by request and create a data file** can start a trigger by click on **Trigger Now**.

The **Status and information** section allows to update or download the SOH file.

- **Request actual status of the system in a file** allows to user to delete all or a specific type of file. It sends a request to the instrument to execute selfcheck and update its state of health. It may take a while to complete, and then you can download updated information in a SOH file.

The **Miscellaneous Requests** section allows to do different tasks:

- **Synchronise instrument time with PC time:** If your instrument does not have a GPS and does not connect to NTP servers, you can set its time from your browser. The method is not very precise.
- **Send a Test Pulse:** By sending this request, a test pulse will be executed. The sensor should then respond accordingly and thus provide information about its status.
- **Remove DC from Signal:** By sending this request, a baseline correction will be applied to the signal and therefore the DC will be removed. A DC on the signal can be caused by e.g. a slight misalignment of the sensor.
- **Battery maintenance command:** if your instruemnt has internal battery, you must update this information every time when you replace it.
- **Send any command:** Type any known command supported by firmware and press **Send**.

If the Seismometer Control option is available, it is possible to control the mass from this window as can be seen in Figure 44. The following commands are supported:

- **Lock:** Locks the seismometer.
- **Unlock:** Unlocks the seismometer. After unlocking, the sensor automatically centres its mass.
- **Center:** Centring of the mass

During all controls, the field *Current Mass Position* shows current mass positions of the channels East-West, North-South and Vertical in mV. Feedback about the progress and status information can be found under *Seismometer Control Output*.

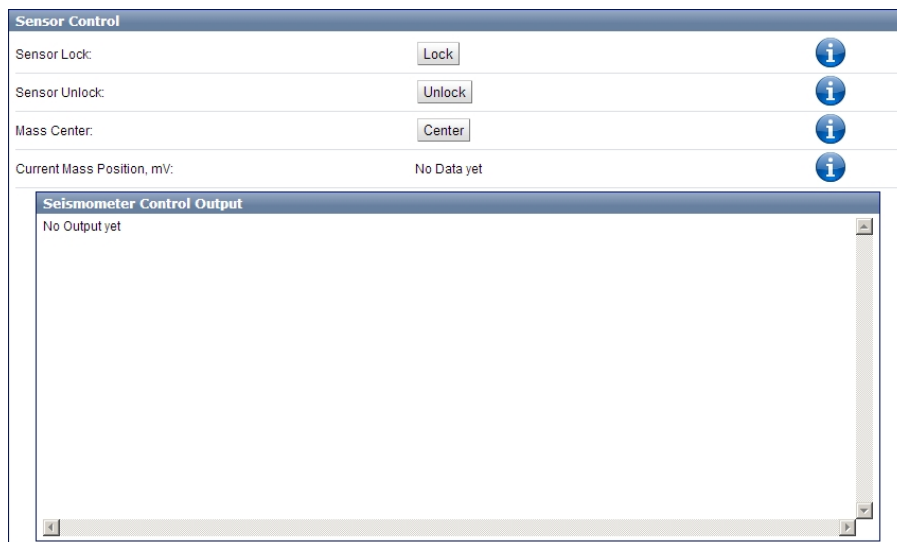

Figure 44: Seismometer Control

## 8.5 Data Explorer

The Data Explorer provides the possibility to gather information on the files stored on the SD or CF card. The file types are separated into three different file types:

- Automatically Detected Events (Event- and Calibration files)
- Manually Triggered Events and Request Data (Event- and Calibration files)
- Status and Information (SOH- and Log-files)
- Ringbuffers (Ringbuffer files)

With the menu at the top of the Data Explorer it is possible to switch between the file types listed above. For each listed file, the information on its file size and the last modification time are displayed. The files can be sorted according to the file name, size or modification date. By clicking on the file name, the file can be downloaded.

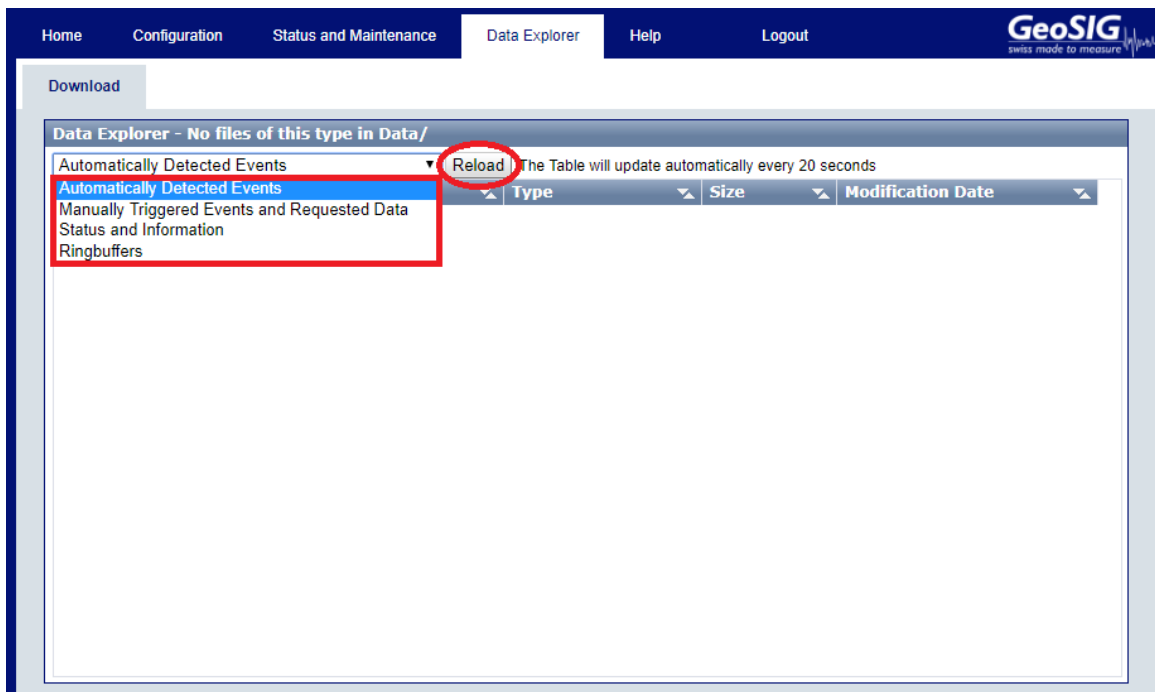

Figure 45: The Data Explorer Screen

## 8.6 Help

The Help Menu provides help if there are any problems with the device or the Web Interface.

### 8.6.1 Online Help

On this screen, the current version of the GMSela User Manual can be downloaded from the device. This manual contains additional information on the instrument, which is not provided in the interface itself.

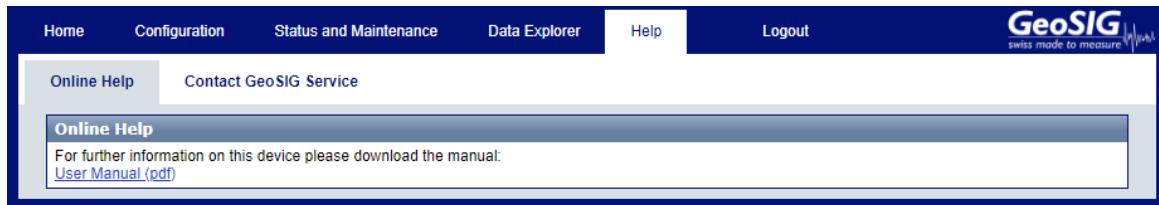

Figure 46: Download the GMSela User Manual

### 8.6.2 Contact GeoSIG Service

This screen provides information on how to contact GeoSIG service in the case of problems. The links provided on this screen will only work if access to the Internet is available.

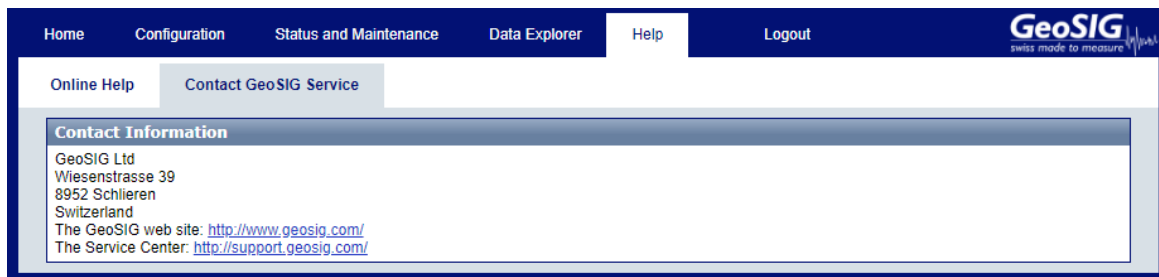

Figure 47: Contact information

## 9 Detailed Configuration of the Instrument

### 9.1 Switch ON and OFF the Instrument

The instrument operates as follows:

- As soon as any power source is available, from the AC/DC power adapter or the PoE, the instrument will automatically start.
- The *SYSTEM* indicator changes to solid white indicating that the operating system is starting up and then it is flashing white indicating that the data acquisition software is starting up. See Table 1 for details about the LED indications.

To turn the instrument **OFF** properly and to avoid any undesired remote power-off, the instrument service console must be used.

- Connect the USB cable on the **CONSOLE** port of the device (See chapter 3.2)
- Open any terminal program and choose the appropriate COM port. Baud rate is 115200. Alternatively open GeoDAS, go to **Tools** → **Terminal ...** and choose the COM Port. As Baud rate select **115200**. Then Press **Connect**. Press enter and the main menu will be displayed.
- Navigate the menu to **U - Control requests** → **8 - Halt the system for manual power off**
- The instrument will be halted and shut down. After the following lines are printed on the console, the power can be disconnected. If the user does not remove power within 20 minutes, the device will power on again.

```
Unmounting local filesystems...
reboot: Power down
gs-mgms-sup sup0: system halted
gs-mgms-sup sup0: disconnect power or push the power button now,
otherwise restart will happen
```

### 9.2 General Comments to the Configuration

All the configuration changes can be done either over the network by the Web Interface and GeoDAS or on the instrument itself using a standard Mini USB patch cable on the internal Micro USB connector and a terminal program.

#### 9.2.1 Change Configuration by the Web Interface

- Open an Internet browser and enter the IP address of the device in the address bar of your browser.
- Login with the username: *admin* and the password: *123456*

See chapter 8 for the full explanation of the Web Interface.

#### 9.2.2 Change Configuration by GeoDAS

- In the window *Stations: General Information* make a **right click** on the station name.
- GeoDAS is opening the default Internet browser. The Web Interface of the instrument will appear. See chapter 8 for the full explanation of the Web Interface.

#### 9.2.3 Changing Configuration by the Console

- Connect the GMSela to a serial port of your computer and switch on the instrument if not already done.
- In GeoDAS go to **Tools** → **Terminal...** and choose your COM Port. As Baud rate select **115200**. Then Press **Connect**. Any terminal application of your choice can be used alternatively.
- Press **<Enter>** the following menu appears:



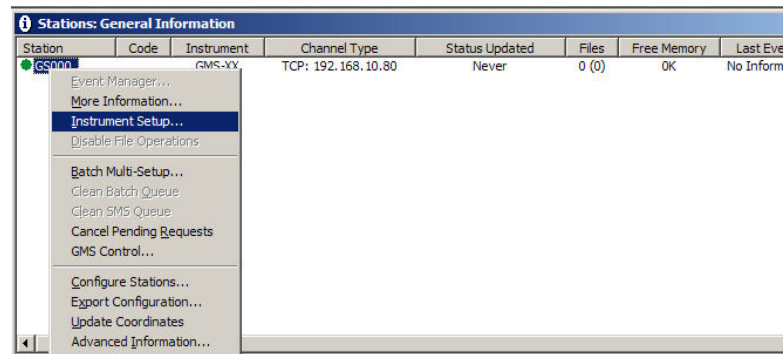

Figure 48: Instrument setup

```

Main menu:
C - Configuration ->
M - Messages ->
X - Display errors (0) and warnings (0)
W - Clear errors and warnings
T - File statistics
I - System information ->
S - Shell command
U - Control requests ->
R - Restart firmware
Z - Reboot instrument
Q - Quit
    
```

- To configure armdas, from GMSela console, press '**C**' and **<Enter>**. If you are asked, select to edit the **current configuration**, by pressing '**C**' again.

```

Configuration selection:
A - Active (creates temp config with current values from memory) ->
C - Current (loads config from config.xml) ->
F - File (take config from specified file) ->

Select <A>...<F>. <Esc> to exit
    
```

- Change the configuration as described in the following chapters
- Press **<Esc>** to leave the configuration menu. If asked, select **save as current configuration**, by pressing '**C**'

```

Save as (C)urrent, save to a (F)ile or e(X)it without saving?
    
```

### 9.2.4 Explanation of the Structure in the Manual

As the parameters in the configuration sometimes depend on each other, not all parameters are shown all the time. The configuration is also sorted in several sub-menus. Therefore the menu is explained as following:

<i>Parameter in the menu</i>		<i>Possible selections</i> or 'User selectable'	Explanation
<b>Switch-Parameter</b>		<i>Possible selections</i> or 'User selectable'	Explanation: The following three lines depend on the selection and are only visible if not set to ' <b>No</b> '
<i>This Parameter is only visible if Switch-Parameter has been set to Yes</i>		<i>Possible selections</i> or 'User selectable'	Explanation
<i>This Parameter is only visible if Switch-Parameter has been set to Yes</i>		<i>Possible selections</i> or 'User selectable'	Explanation
<i>Submenu, only visible if Switch-Parameter has been set to Yes</i>	<i>Parameter in the Submenu</i>	<i>Possible selections</i> or 'User selectable'	Explanation
	<i>Parameter in the Submenu</i>	<i>Possible selections</i> or 'User selectable'	Explanation
<b>Submenu</b>	<i>Parameter in the Submenu</i>	<i>Possible selections</i> or 'User selectable'	Explanation
	<i>Parameter in the Submenu</i>	<i>Possible selections</i> or 'User selectable'	Explanation
	<i>Switch-Parameter in the Submenu</i>	<i>Possible selections</i> or 'User selectable'	Explanation
	<i>This Parameter is only visible if Switch-Parameter has been set to Yes</i>	<i>Possible selections</i> or 'User selectable'	Explanation

Table 3: Explanation table structure

## 9.3 Configuration of the Channels

### 9.3.1 In the Web Interface or by GeoDAS

- In the field **Configuration** → **Number of Channels** the total number of channels must be configured first.

The screenshot displays the GeoSIG Configuration Manager web interface. The top navigation bar includes 'Home', 'Configuration', 'Status and Maintenance', 'Data Explorer', 'Help', and 'Logout'. Below this, the 'Configuration Manager' section is active, with sub-tabs for 'Data Acquisition', 'Configuration Manager', 'Network', and 'Web Interface'. The 'Main menu' contains several configuration items:

Field	Value	Info Icon
Station description	GeoSIG Station	Yes
Station code	GSGMS	Yes
Location description	Default location	Yes
Seismic network code	GS	Yes
Number of Channels	3	No
Number of Output Streams	0	No
Number of Trigger Sets	1	No
Number of Preset Triggers	0	No
Channel Parameters	>>	No
Trigger Parameters	>>	No
File Storage and Policy	>>	No
Communication Parameters	>>	No
Miscellaneous Parameters	>>	No
Sensors and Virtual Channels	>>	No
GeoSIG Options	>>	No
Time synchronization	>>	No

At the bottom of the interface, there are four buttons: 'Back', 'Load from Device', 'Save Changes', and 'Apply and Restart'. The 'Number of Channels' field and the 'Channel Parameters' section are highlighted with red boxes in the original image.

Figure 49: Configure Number of Channels

- Go to **Configuration** → **Channel Parameters** to edit the channel parameters. See Table 4 for additional information.

The screenshot shows the GeoSIG web interface. The top navigation bar includes 'Home', 'Configuration', 'Status and Maintenance', 'Data Explorer', 'Help', and 'Logout'. Below this, there are sub-navigation tabs: 'Data Acquisition', 'Configuration Manager', 'Network', and 'Web Interface'. The main content area displays a table of channel parameters:

No	Data source	Channel name	Location code	Maintain the ringbuffer	Online preprocessing
<b>1</b>	<b>INT-ADC-S01-C01</b>	<b>C01</b>	<b>LC</b>	<b>Yes</b>	<b>None</b>
2	INT-ADC-S01-C02	C02	LC	Yes	None
3	INT-ADC-S01-C03	C03	LC	Yes	None

Below the table, a note states: "The above table displays several main parameters. Click a row to select it. Hold the Ctrl button to select multiple rows. The last clicked row is displayed in bold and parameters of the related item are displayed in the panel below. Modification of any parameter is applied to all selected rows".

The configuration panel for 'Channel 1 of 3' includes the following parameters:

- Data source: INT-ADC-S01-C01 (dropdown)
- Channel name: C01 (text input)
- Location code: LC (text input)
- Source data unit: g (text input)
- LSB factor: 2.50986e-07 (text input)
- Sampling rate, sps: 1000 (text input)
- Negative axis:
- Offset compensation:
- Maintain the ringbuffer:
- Online preprocessing: None (dropdown)
- Decimation and peaks: None (dropdown)

At the bottom of the panel are buttons for 'Back', 'Load from Device', 'Save Changes', and 'Apply and Restart'.

Figure 50: Edit Channel Parameters

### 9.3.2 Via Local Serial Console

- Press **'E'** to select the number of channels. By default three channels are configured as most sensors have three channels normally.

```
Configuration
A) Station description ..... GeoSIG Station
B) Station code ..... GSGMS
C) Location description ..... Default location
D) Seismic network code ..... GS
E) Number of Channels ..... 3
F) Number of Output Streams ..... 0
G) Number of Trigger Sets ..... 1
H) Number of Preset Triggers ..... 0
I) Channel Parameters ..... ->
K) Trigger Parameters ..... ->
M) File Storage and Policy ..... ->
N) Communication Parameters ..... ->
O) Miscellaneous Parameters ..... ->
S) GeoSIG Options ..... ->
T) Time synchronization ..... ->
```

- Press **'I'** to get to the *Channel Parameters* menu to adjust the settings of the channels. The following menu appears:

```
Configuration | Channel 1 of 3
A) Data source ..... INT-ADC-S01-C01
E) Channel name ..... C01
F) Location code ..... LC
G) Source data unit ..... g
H) LSB factor ..... 2.50986e-07
I) Sampling rate, sps ..... 1000 (0x3E8)
K) Negative axis ..... No
L) Offset compensation ..... Yes
N) Maintain the ringbuffer ..... Yes
O) Online preprocessing ..... None
S) Decimation and peaks ..... None
```

- Each channel can be adjusted according to your wishes. To change the channels press **'+'** or **'-'**. The following parameters can be adjusted:

<b>Data source</b>	The source of the channel can be defined	
	<b>INT-ADC-Sxx-Cxx</b> <b>EXT-ADC-Sxx-Cxx</b> <b>DATACHAN</b> <b>DATAVSUM</b> <b>DATAVSU3</b>	See chapter <a href="#">9.3.4</a>  Virtual channels Vector sum of two channels Vector sum of three channels
	<b>Source channel name</b>	<i>User selectable</i> The source of the virtual channel can be any other channel
	<b>Second source channel</b>	<i>User selectable</i> In case of the vector sum a second or third source has to be selected
	<b>Third source channel</b>	<i>User selectable</i>
<b>Channel name</b>	<i>User selectable</i>	The channel name in the record is a combination of the location code and channel name
<b>Location code</b>	<i>User selectable</i>	
<b>Source data unit</b>	<i>User selectable</i>	Data unit of the selected channel
<b>LSB factor</b>	<i>User selectable</i>	LSB factor, depending on the connected sensor. See chapter ?? for details and Table ?? for the specific values of the sensors.
<b>Sampling rate, sps</b>	<b>20, 40, 50, 100, 125, 200, 250, 500, 1000, 2000*, 2500*, 5000*</b>	Sampling rate of the selected channel. Additional sampling rates can be derived by configuring a decimation factor in the decimation and peaks option. (*) Not supported in all models.
<b>Negative axis</b>	<b>Yes</b> <b>No</b>	Inversion of the axis is enabled Inversion of the axis is disabled
<b>Offset compensation</b>	<b>Yes</b> <b>No</b>	Compensation is enabled Compensation is disabled Detail behavior of the offset compensation can be configured as described in chapter <a href="#">9.9.2</a>
<b>Maintain Ringbuffer</b>	<b>Yes</b> <b>No</b>	Permanent recording is enabled Permanent recording is disabled
<b>Decimation and peaks</b>	The data can be decimated, or just peaks can be stored	
<b>Online Decimation</b>	<b>Decimation</b> <b>Peak Values</b> <b>Average Values</b>	Additional down sampling of the data Peak values of the data within a certain interval Average values of the data within a certain interval
<b>Decimation factor</b>	<i>User selectable</i>	The signal will be decimated by the selected factor. E.g. if the sample rate is 50 and the decimation factor 10, then the output sample rate is 5 SPS. Be aware that no anti-aliasing filtering is done prior to decimation!
<b>Interval of calculation, sec</b>	<i>User selectable</i>	The Peak or Average values of the signal within the time defined in the Interval of averaging will be written into the ringbuffer with the specified Output sampling interval in [seconds]. Interval of averaging should be equal or higher than the Output sampling interval.
<b>Output sampling interval, sec</b>	<i>User selectable</i>	

Table 4: Channel configuration menu structure

### 9.3.3 LSB factor

This section defines the calculation of the LSB value for the GMSela that has to be configured in the Channel Parameters.

The GMSela can be provided with 2 different full scale:  $\pm 1g$  or  $\pm 4g$ . The actual full scale can't be changed by the user and it is reported on the label attached on the device. The instrument is shipped with the correct LSB value according to the device full scale and it should correspond to the following values:

- $\pm 1g$  instrument  $\rightarrow$  LSB = 1.577009073504E-07 (g/count)
- $\pm 4g$  instrument  $\rightarrow$  LSB = 4.731027220511E-07 (g/count)

### 9.3.4 Channel Naming

The naming of the channels is organised as following: all internal sensors start with **INT-ADC**, all external sensors with **EXT-ADC**.

#### xxx-ADC-Syy-Czz

xxx	Source	INT	Internal Sensor
		EXT	External Sensor
yy	Sensor	3ch: S01	
		6ch: S01,S02	
zz	Channel	C01 ... C03	

For example if there are two external sensors connected, the following channels are available:

EXT-ADC-S01-C01	EXT-ADC-S02-C01
EXT-ADC-S01-C02	EXT-ADC-S02-C02
EXT-ADC-S02-C03	EXT-ADC-S02-C03

## 9.4 Configuration of Data Streams

### 9.4.1 In the Web Interface or by GeoDAS

- In the field **Configuration** → **Number of Output Streams** the total number of output streams must be configured first so that the **Stream Parameters** menu appears.

Main menu		
Station description	GeoSIG Station	
Station code	GSGMS	
Location description	Default location	
Seismic network code	GS	
Number of Channels	3	
Number of Output Streams	1	
Number of Trigger Sets	1	
Number of Preset Triggers	0	
Channel Parameters	>>	
Stream Parameters	>>	
Trigger Parameters	>>	
File Storage and Policy	>>	
Communication Parameters	>>	
Miscellaneous Parameters	>>	
Sensors and Virtual Channels	>>	
GeoSIG Options	>>	
Time synchronization	>>	

Back Load from Device Save Changes Apply and Restart

Figure 51: Configure number of Output Streams

- Go to **Configuration** → **Stream Parameters** to edit the stream parameters. See Table 5 for additional information.

Main menu   Stream		
Stream name	Stream_1	
Stream type	GSBU	
Port configuration	>>	
Channels in the stream	3	
List of streamed channels	>>	
Data frames per packet	5	
CRC32 protected packets	<input type="checkbox"/>	
Number of padding bytes	0	

Back Load from Device Save Changes Apply and Restart

Figure 52: Edit Stream Parameters



### 9.4.2 Via Local Serial Console

- Press '**F**' to select the *Number of Output Streams*. One output stream can have several channels.

```
Configuration
A) Station description ..... GeoSIG Station
B) Station code ..... GSGMS
C) Location description ..... Default location
D) Seismic network code ..... GS
E) Number of Channels ..... 3
F) Number of Output Streams ..... 1
G) Number of Trigger Sets ..... 1
H) Number of Preset Triggers ..... 0
I) Channel Parameters ..... ->
J) Stream Parameters ..... ->
K) Trigger Parameters ..... ->
M) File Storage and Policy ..... ->
N) Communication Parameters ..... ->
O) Miscellaneous Parameters ..... ->
S) GeoSIG Options ..... ->
T) Time synchronization ..... ->
```

- Press '**J**' to get to the *Stream Parameters* menu to adjust the settings of the output streams. The following menu appears:

```
Configuration | Stream
A) Stream name ..... Stream_1
B) Stream type ..... GSBU
C) Port configuration ..... ->
D) Channels in the stream ..... 3
E) List of streamed channels ... ->
F) Data frames per packet ..... 5 (0x05)
G) CRC32 protected packets ..... No
H) Number of padding bytes ..... 0 (0x00)
```

- Each output stream can be adjusted according to your wishes. To change the output stream press '+' or '-'. The following parameters can be adjusted:

'+' and '-' can be used to change between the channels			
<b>Stream name</b>	User selectable	Name of the output stream	
<b>Stream type</b>	<b>GSBU</b>	Streaming possibly in GSBU format only	
<b>Port configuration</b>	<b>Communication Port</b>	<b>TCP/IP</b>	Streaming over the network
	<b>Protocol</b>	<b>TCP(SERVER)</b>	GeoDAS software or any other client supporting the selected protocol connects to the IP address configured under 'IP Address' for data streaming
	<b>Network Port</b>	User selectable	Server port listening for incoming connections
	<b>Baud Rate</b>	<b>1200</b> <b>2400</b> <b>4800</b> <b>9600</b> <b>19200</b> <b>38400</b> <b>57600</b> <b>115200</b>	Baud rate of the serial data stream. Make sure that the serial port of the computer is configured to the same baud rate.
<b>Channels in the stream</b>	User selectable	Number of channels which should be streamed	
<b>List of streamed channels</b>	'+' and '-' can be used to change the channels		
	<b>Assigned channel name</b>	User selectable	Depending on the number of channels, for every channel a different source can be selected; the source can be selected by pressing 'A'.
<b>Data frames per packet</b>	User selectable	Specifies the packet length of the streams (one data frame is equal to 200 ms). For example if '5' is selected, then every second a packet with the last second of data will be sent.	
<b>CRC32 protected packets</b>	<b>Yes</b> <b>No</b>	Enable CRC32 protection for the stream Disable CRC32 protection for the stream	
<b>Number of padding bytes</b>	User selectable	Add the specified number of padding bytes to the stream	

Table 5: Data streaming configuration menu structure

### 9.4.3 Set up of Data Streams

This chapter will describe how to set up an instrument for data streaming.

#### 9.4.3.1 In the Web Interface or by GeoDAS

- Connect to the Web Interface and configure the number of the Data Streams in the field **Configuration** → **Number of Output Streams**. One output stream can have several channels.
- Go to **Configuration** → **Stream Parameters** to adjust the settings of the output streams.

#### 9.4.3.2 Via Local Serial Console

- Connect to the instrument and press **'F'** to select the *Number of Output Streams*. One output stream can have several channels.
- Press **'J'** to get to the *Stream Parameters* menu to adjust the settings of the output streams.
- Adjust the settings according to chapter 9.4. Carefully select the settings in the *Port Configuration*. If you want to stream over Ethernet, choose **TCP/IP** and **TCP (Server)**.

```
Configuration | Stream | Port
A) Communication port ... TCP/IP
C) Protocol ..... TCP (Server)
E) Network port ..... 4001 (0xFA1)
```

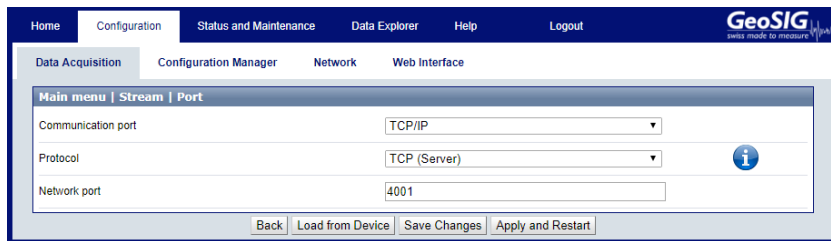

- If you want to stream over the SERIAL port on the front of the instrument, choose **ttyS03**.

```
Configuration | Stream | Port
A) Communication port ... ttyS03
B) Baud rate ..... 115200
```

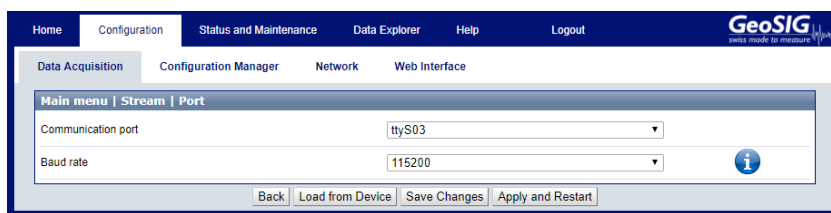

- Open **GeoDAS** and go to the menu **Settings** → **Channels of Digitizers...** The following window appears:

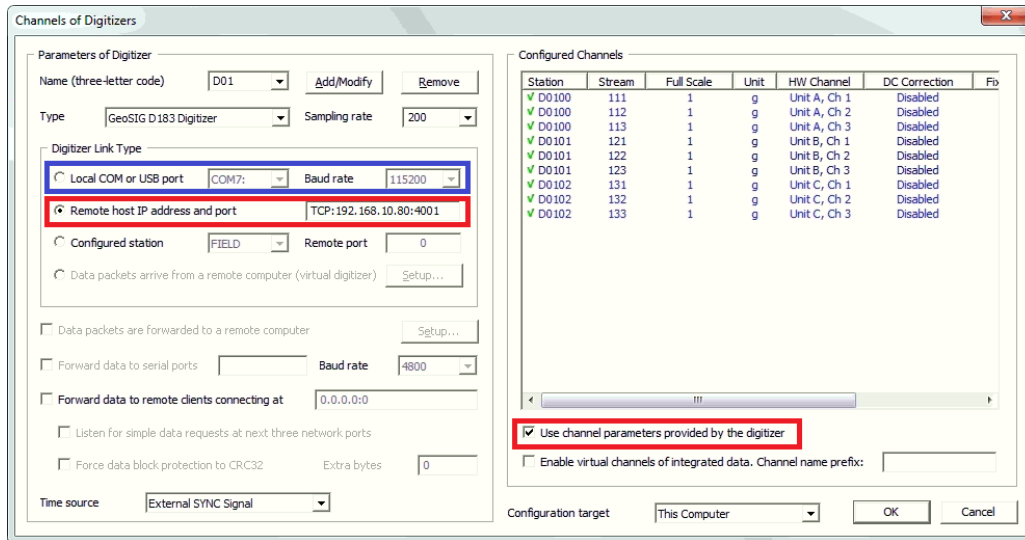

Figure 53: Channels of Digitizers

- Adjust the **Name**, choose any three-letter code for the data stream
- Select as **Type** the **GeoSIG Packet Digitizer**
- Press **Add/Modify**
- Make sure the selected **Sample rate** is the same as in the instrument.
- Choose either the **Local COM port** (if connected over RS-232) or the **Remote host IP address and port** (if connected over Ethernet). The instrument's IP address must be known.
- Check the flag **Use channel parameters provided by the digitizer**.
- Press **OK**.
- After a restart of **GeoDAS**, the window **Stations: Data Streams** appears:

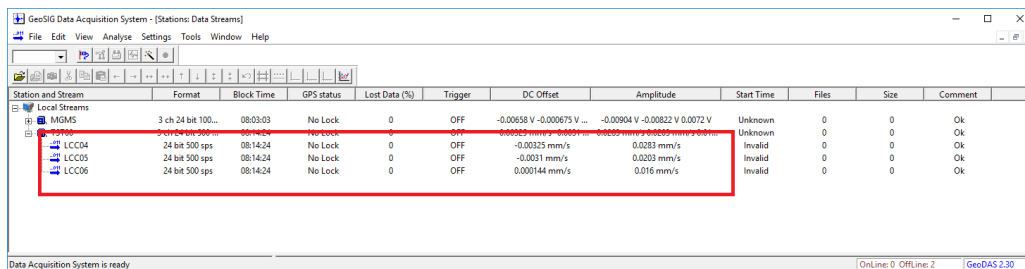

Figure 54: Stations: Data Streams

- To view the data make a right click on the station name (here TST00) and select **Data Monitor**

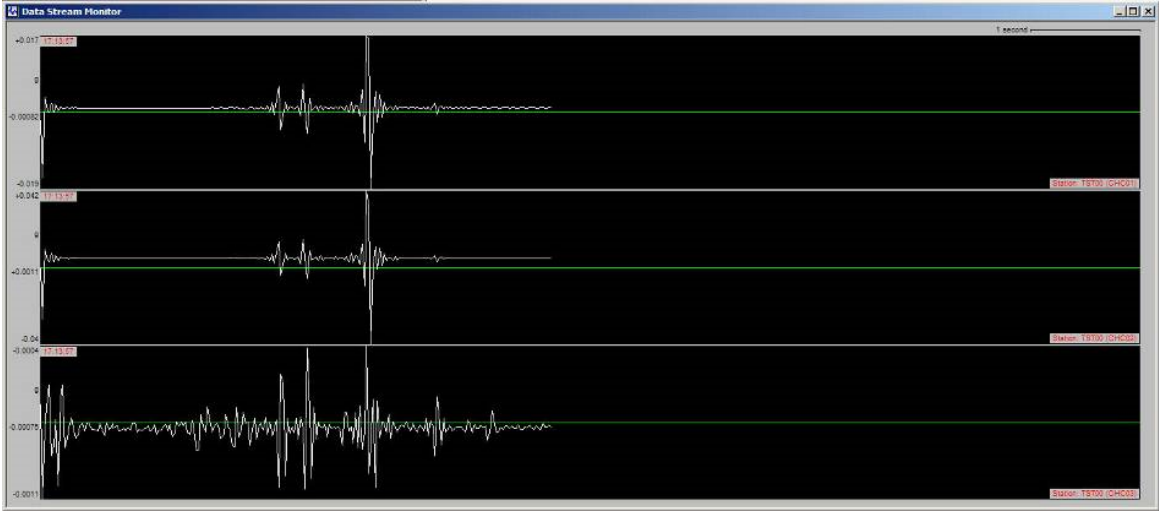

Figure 55: Data stream window

## 9.5 Trigger Settings

The instrument allows having several triggers with independent sources in parallel.

### 9.5.1 In the Web Interface or by GeoDAS

- Go to **Configuration** → **Number of Trigger Sets** and configure the number of the desired Trigger Sets.

The screenshot shows the 'Configuration Manager' section of the GeoSIG web interface. The 'Number of Trigger Sets' field is highlighted with a red box and contains the value '2'. Below it, the 'Trigger Parameters' section is also highlighted with a red box and contains a '>>' button. Other configuration fields include 'Station description' (GeoSIG Station), 'Station code' (GSGMS), 'Location description' (Default location), 'Seismic network code' (GS), 'Number of Channels' (3), 'Number of Output Streams' (1), 'Number of Preset Triggers' (0), 'Channel Parameters', 'Stream Parameters', 'File Storage and Policy', 'Communication Parameters', 'Miscellaneous Parameters', 'Sensors and Virtual Channels', 'GeoSIG Options', and 'Time synchronization'. The interface includes a top navigation bar with 'Home', 'Configuration', 'Status and Maintenance', 'Data Explorer', 'Help', and 'Logout'. A bottom navigation bar contains 'Back', 'Load from Device', 'Save Changes', and 'Apply and Restart' buttons.

Field	Value
Station description	GeoSIG Station
Station code	GSGMS
Location description	Default location
Seismic network code	GS
Number of Channels	3
Number of Output Streams	1
Number of Trigger Sets	2
Number of Preset Triggers	0
Channel Parameters	>>
Stream Parameters	>>
Trigger Parameters	>>
File Storage and Policy	>>
Communication Parameters	>>
Miscellaneous Parameters	>>
Sensors and Virtual Channels	>>
GeoSIG Options	>>
Time synchronization	>>

Figure 56: Configure number of trigger sets

- To edit a trigger go to **Configuration** → **Trigger Parameters**. See Table 6 for additional information.

The screenshot shows the GeoSIG Configuration Manager interface. At the top, there are navigation tabs: Home, Configuration (selected), Status and Maintenance, Data Explorer, Help, and Logout. Below these are sub-tabs: Data Acquisition, Configuration Manager (selected), Network, and Web Interface. The main content area features a table with the following data:

No	Triggerset name	Trigger source	Trigger time frame, sec	Count trigger votes by	Event recording
1	Trigger1	Local triggers	3	Channels	Yes
2	Trigger2	Local triggers	3	Channels	Yes

Below the table, a text block states: "The above table displays several main parameters. Click a row to select it. Hold the Ctrl button to select multiple rows. The last clicked row is displayed in bold and parameters of the related item are displayed in the panel below. Modification of any parameter is applied to all selected rows".

The main configuration panel is titled "Main menu | Triggerset 1 of 2". It contains the following parameters:

- Triggerset name: Trigger1
- Trigger source: Local triggers
- Trigger time frame, sec: 3
- Count trigger votes by: Channels
- Minimum number of votes: 1
- Monitored channels: 3
- Trigger channel settings: >>
- Event recording:
- Preevent, seconds: 5
- Postevent, seconds: 5
- Maximum event duration, seconds: 30
- Stored channels: 6
- List of stored channels: >>
- Contribute to network triggers:

At the bottom of the panel, there are four buttons: Back, Load from Device, Save Changes, and Apply and Restart.

Figure 57: Edit Trigger Parameters

### 9.5.2 Via Local Serial Console

- Press 'G' to select the *Number of Trigger Sets*

```
Configuration
A) Station description ..... GeoSIG Station
B) Station code ..... GSGMS
C) Location description ..... Default location
D) Seismic network code ..... GS
E) Number of Channels ..... 3
F) Number of Output Streams ..... 1
G) Number of Trigger Sets ..... 1
H) Number of Preset Triggers ..... 0
I) Channel Parameters ..... ->
J) Stream Parameters ..... ->
K) Trigger Parameters ..... ->
M) File Storage and Policy ..... ->
N) Communication Parameters ..... ->
O) Miscellaneous Parameters ..... ->
S) GeoSIG Options ..... ->
T) Time synchronization ..... ->
```

- Press 'K' to get to the *Trigger Parameters* menu to adjust the settings of the triggers. The following menu appears. In case the number of trigger sets is set to '0' this menu can not be selected.

```
Configuration | Triggerset
A) Triggerset name ..... Trigger1
B) Event recording ..... No
D) Alarm activation ..... No
E) SMS Alarm Configuration ..... No
I) Trigger time frame, sec ..... 3 (0x03)
K) Monitored channels ..... 3
L) Trigger settings ..... ->
O) Be a source of network triggers (received from LAN) ... No
P) Activate on network triggers (received from LAN) ..... No
Q) Be a source of network triggers (Interconnection) ..... No
R) Activate on network triggers (Interconnection) ..... No
```

- Each trigger set can be adjusted according to your wishes. To change the trigger set press '+' or '-'. The following parameters can be adjusted:



‘+’ and ‘-’ can be used to change between the channels				
<b>Triggerset name</b>	User selectable	Name of the trigger set		
<b>Trigger time frame, sec</b>	User selectable	See chapter 9.5.5 for details		
<b>Trigger source</b>	<b>Network voting logic</b> <b>Local triggers</b>	Choose the trigger source		
<b>Support triggers through Interconnection</b>	<b>Yes</b>	This recorder will broadcast a Network Trigger Alert (in case the instrument is interconnected over RS-485 with other instruments) as soon as this triggerset becomes active. No trigger through interconnection		
	<b>No</b>			
<b>Serial numbers of networked instruments</b>	User selectable	Whitespace or comma separated list of instruments which contribute to the Network voting logic.		
<b>Contribute to network triggers</b>	User selectable	If this option is active, this recorder will broadcast a Network Trigger Alert		
<b>Monitored channels</b>	User selectable	Number of channels which will be monitored by the selected trigger set		
<b>Count trigger votes by</b>	<b>Channels</b> <b>Channel weight</b> <b>Sensor</b> <b>Station</b>	Choose one trigger vote in this list		
<b>Minimum number of votes</b>	User selectable	Define the number of incoming network triggers of the same name that have to be observed in order to make this device trigger		
<b>Trigger channel settings</b>	<b>Assigned channel name</b>	User selectable	Configure the first Data Source for this channel.	
	<b>Trigger filter</b>	<b>Yes</b>	Trigger filter is used as defined under Filter Parameters	
		<b>No</b>	Trigger filter is not used	
	<b>Filter parameters</b>	<b>Filter type</b>	<b>Highpass</b> <b>Lowpass</b> <b>Bandpass</b>	A Highpass will attenuate all frequencies below a defined frequency. A Lowpass will attenuate all frequencies above a defined frequency. A Bandpass will attenuate all frequencies below a defined frequency and above a defined frequency.
		<b>Filter order</b>	User selectable	Defines how much the attenuation increases per decade below the Low Frequency Corner respectively above the High Frequency Corner. The attenuation increases by the filter order multiplied with 20 dB. User can choose between these values: [2-4-6-8-10-12]
		<b>Flow, Hz</b>	User selectable	The Low Frequency Corner of the filter is the point where the attenuation is 3 dB. Below this frequency, attenuation will increase depending on the Filter Type
<b>Fhigh, Hz</b>		User selectable	The High Frequency Corner of the filter is the point where the attenuation is 3 dB. Above this frequency, attenuation will increase depending on the Filter Type	

<b>Trigger channel settings (continued)</b>	<b>Level Trigger</b>	<b>Yes</b> <b>No</b>	Level trigger is enabled Level trigger is disabled
	<b>Threshold (channel units)</b>	User selectable	As soon the data is above the configured threshold the trigger is activated
	<b>Min. level exceedance, sec</b>	User selectable	The threshold or STA/LTA ratio has to be exceeded at least for the configured time in seconds to active the trigger
	<b>STA/LTA Trigger</b>	<b>Yes</b> <b>No</b>	STA/LTA trigger is enabled STA/LTA trigger is disabled
	<b>STA time frame, sec</b>	User selectable	Length of STA time window, seconds
	<b>LTA time frame, sec</b>	User selectable	Length of LTA time window, seconds
	<b>STA/LTA trigger ratio</b>	User selectable	As soon the data is above the configured STA/LTA ratio the trigger is activated
	<b>STA/LTA dettrigger ratio</b>	User selectable	As soon the data is below the configured STA/LTA ratio again the trigger is deactivated
	<b>Min. ratio exceedance, sec</b>	User selectable	The threshold or STA/LTA ratio has to be exceeded at least for the configured time in seconds to active the trigger
	<b>Clamp LTA during event</b>	<b>Yes</b>  <b>No</b>	As soon the data is below the configured STA/LTA ratio again the trigger is deactivated
	<b>Channel trigger weight, %</b>	User selectable	See chapter 9.5.4 for details
<b>Event recording</b>		<b>Yes</b> <b>No</b>	An event file will be recorded on a trigger No event file will be recorded on a trigger
	<b>Pre-event</b>	User selectable	Pre-Event time, seconds
	<b>Post-event</b>	User selectable	Post-Event time, seconds
	<b>Max. event duration, sec</b>	User selectable	Maximum duration of an event in seconds. After this time, an event file will be closed
<b>Event Processing</b>		<b>PGM parameters</b>  <b>No</b>	An event file will be processed and a summary report will be created The event file will not be processed
<b>Stored channels</b>		User selectable	Number of channels, which should be stored into an event file in case of a trigger
<b>List of stored channels</b>	'+' and '-' can be used to change the channels		
	<b>Assigned channel name</b>	User selectable	Depending on the number of channels, for every channel a different source can be selected; the source can be selected by pressing 'A'.

<b>Alarm activation</b> (Only visible in case alarm relay card is installed)		<b>Yes</b> <b>No</b>	An alarm relay will be activated on a trigger No alarm relay will be activated on a trigger This option has an effect only in case the instrument has internal alarm relays
<b>Alarm output to activate</b>		<b>AL1, AL2,</b>  <b>AL3*, AL4*</b>	select the alarm output you want to activate in case of a trigger. (*) Not available in all models
<b>Alarm deactivation delay</b>		User selectable	Time in seconds the alarm relay deactivates again after the signal falls below the trigger threshold. Can be compared to the post event time for the recording
<b>Alarm acknowledge</b>		User selectable	Digital input to acknowledge and reset the alarm. See appendix <a href="#">A</a>
<b>Send SOH upon alarm activation</b>		<b>Yes</b>  <b>No</b>	Defines whether a SOH information will be created and transferred to the server upon alarm deactivation
<b>SMS Alarm</b>		<b>Yes</b> <b>No</b>	An SMS will be sent upon a trigger No SMS will be sent upon a trigger
(This option is available only in case an external cellular modem is connected to the instrument.)			
<b>SMS Alarm Configuration</b>	<b>Number of Recipients</b>		User selectable The number of recipients of the SMS alarm can be selected
	<b>Recipient</b>	'+' and '-' can be used to change the channels	
		<b>Recipient</b>	User selectable

Table 6: Trigger settings configuration menu structure

### 9.5.3 STA/LTA trigger

The STA/LTA (Short Time Average/Long Time Average) ratio trigger computes the short term and long term averages of the input (sensor) signal. When the STA exceeds a pre-selected multiple of the LTA (STA/LTA ratio), the instrument begins to record data. The advantage of this trigger type is that the trigger sensitivity adapts to the seismic background signal. With an increasing noise level the trigger sensitivity decreases. The probability of having a false trigger due to noise will be minimised if a long STA averaging time is selected. Obviously, the STA should not be chosen longer than the shortest event of interest. In addition, the STA should be shorter than the pre-event time. If not, the initial portion of an event may not be recorded. During the steady state of the system, the STA and the LTA will be nearly equal. The shorter STA averaging period, the more quickly it will change with the input.

### 9.5.4 Trigger Weight

To activate a trigger the total trigger weight must be equal or bigger than 100%. By default all channels have a weight of 100%, which means if a threshold is exceeded on one channel only, then the trigger is activated. If the trigger weight were reduced on all channels to 50%, then at least on two channels the threshold would have to be exceeded to reach 100% (50% + 50%) and activate the trigger. See Figure 58 for details.

### 9.5.5 Trigger Time Frame

Depending on the settings, it can be that threshold must be exceeded on two or more channels to activate the trigger. The time of the threshold-exceedances might be slightly different on the channels, especially if two

sensors are connected and installed on different places. To make sure that even due to this time difference the trigger is working a *trigger time frame* can be defined. See Figure 58 for details.

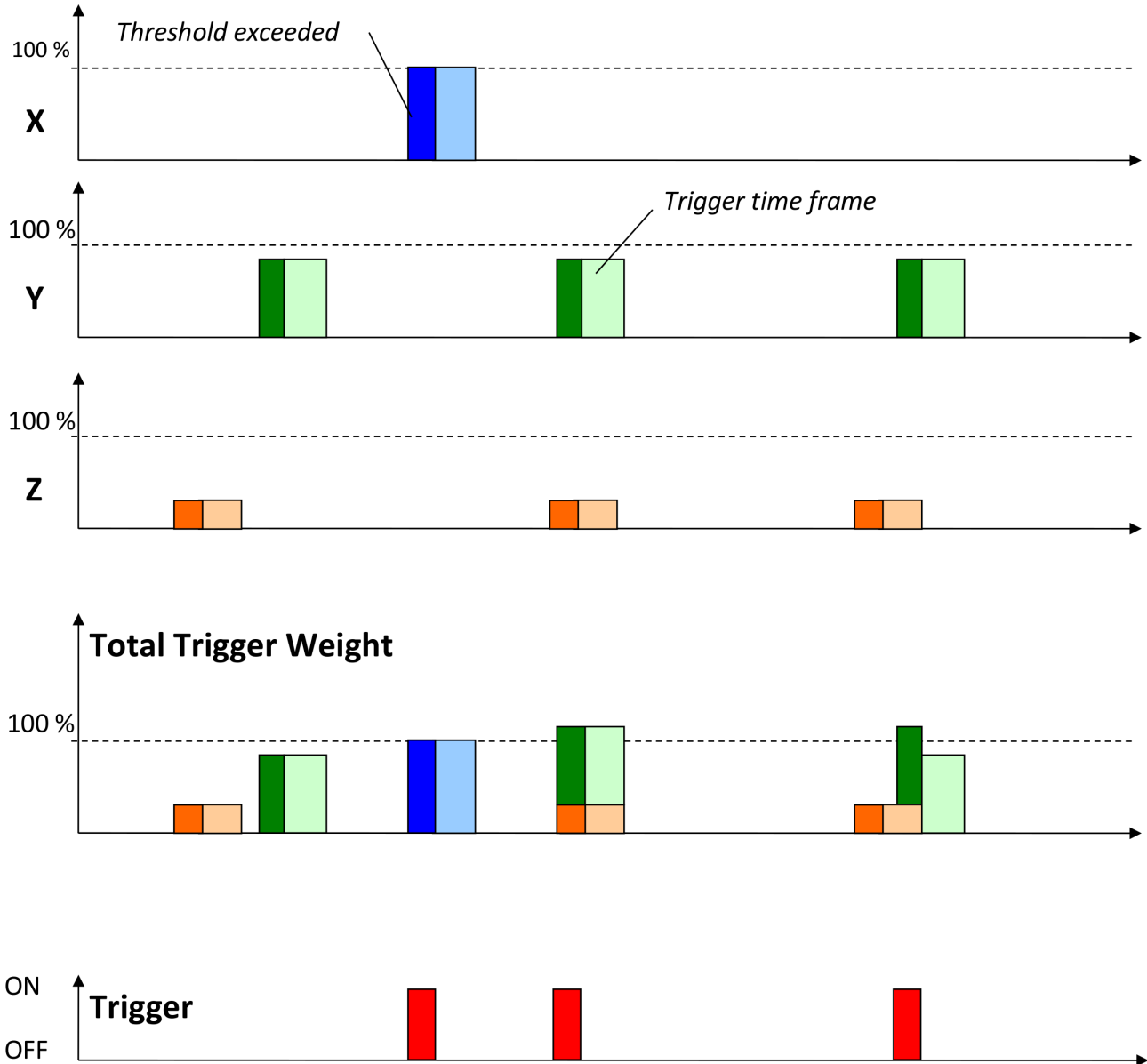

Figure 58: Overview of trigger weight and trigger time frame

## 9.6 Preset Trigger Settings

The instrument allows having several predefined triggers, e.g. time triggers in parallel.

### 9.6.1 In the Web Interface or by GeoDAS

- In the field **Configuration** → **Number of Preset Triggers** the total number of the preset triggers must be configured first so that the **Parameters of Preset Triggers** menu appears.

The screenshot shows the 'Configuration Manager' page in the GeoSIG web interface. The 'Main menu' section contains various configuration fields. The 'Number of Preset Triggers' field is highlighted with a red box and contains the value '2'. Below it, the 'Parameters of Preset Triggers' button is also highlighted with a red box. Other fields include 'Station description' (GeoSIG Station), 'Station code' (GSGMS), 'Location description' (Default location), 'Seismic network code' (GS), 'Number of Channels' (3), 'Number of Output Streams' (1), 'Number of Trigger Sets' (1), 'Channel Parameters', 'Stream Parameters', 'Trigger Parameters', 'File Storage and Policy', 'Communication Parameters', 'Miscellaneous Parameters', 'Sensors and Virtual Channels', 'GeoSIG Options', and 'Time synchronization'. The bottom of the page has buttons for 'Back', 'Load from Device', 'Save Changes', and 'Apply and Restart'.

Figure 59: Configure number of Preset Triggers

- Go to **Configuration** → **Parameters of Preset Triggers** to adjust the parameters of the preset triggers. See Table 7 for additional information.

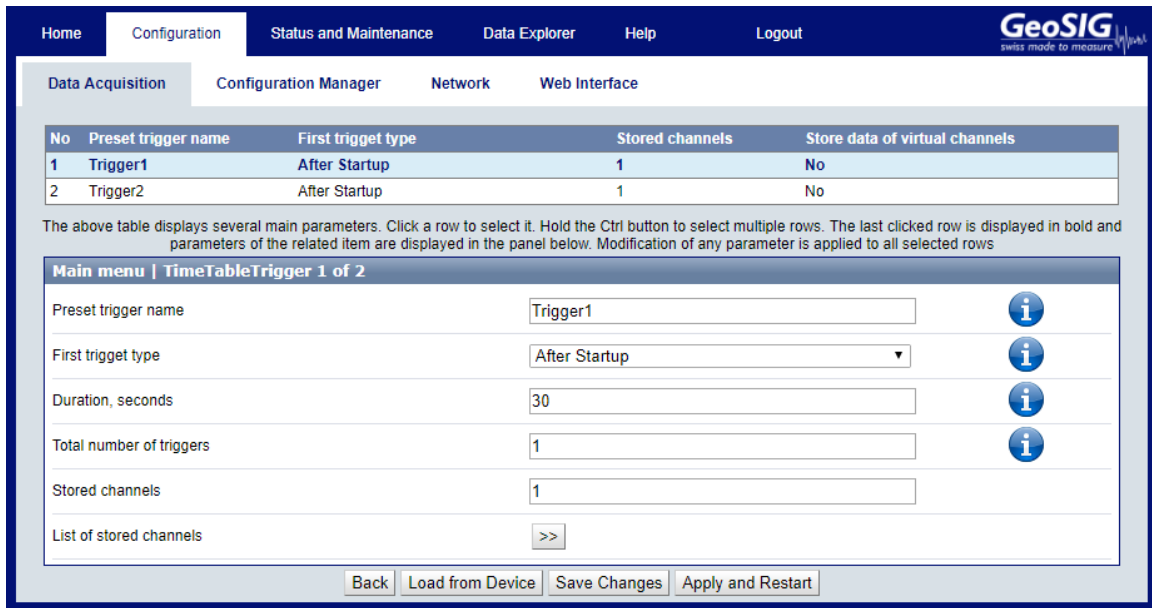

Figure 60: Edit Preset Triggers

### 9.6.2 Via Local Serial Console

- Press **'H'** to select the Number of Preset Triggers

```
Configuration
A) Station description ..... GeoSIG Station
B) Station code ..... GSGMS
C) Location description ..... Default location
D) Seismic network code ..... GS
E) Number of Channels ..... 3
F) Number of Output Streams ..... 1
G) Number of Trigger Sets ..... 1
  H) Number of Preset Triggers ..... 1
I) Channel Parameters ..... ->
J) Stream Parameters ..... ->
K) Trigger Parameters ..... ->
  L) Parameters of Preset Triggers ... ->
M) File Storage and Policy ..... ->
N) Communication Parameters ..... ->
O) Miscellaneous Parameters ..... ->
S) GeoSIG Options ..... ->
T) Time synchronization ..... ->
```

- Press **'L'** to get to the *Parameters of Preset Triggers* menu to adjust the settings of the preset triggers. The following menu appears only if the *number of preset triggers* is higher than **'0'**.

```
Configuration | TimeTableTrigger
A) Preset trigger name ..... Trigger1
B) First trigger type ..... After Startup
H) Duration, seconds ..... 30 (0x1E)
I) Total number of triggers ..... 1 (0x01)
O) Stored channels ..... 1
P) List of stored channels ..... ->
```

- Each trigger set can be adjusted according to your wishes. To change the preset trigger set press **'+'** or **'-'**. The following parameters can be adjusted:

<b>'+' and '-' can be used to change the preset triggers</b>			
<b>Preset trigger name</b>	User selectable	Name of the preset trigger set	
<b>First trigger type</b>	<b>Manual Trigger</b>	A trigger is activated/stopped by the user command TRIGGERNOW/STOPTRIGGER sent either from the console or remotely from a server	
	<b>After Event</b>	A trigger is activated after recording of any event file	
	<b>After Startup</b>	First trigger is activated after the instrument startup	
	<b>Date and Time</b>	First trigger is activated at the defined date/time	
	<b>Hardware Trigger</b>	The trigger is activated by hardware	
	<b>Duration, sec</b>	User selectable	The duration the scheduled trigger will be active
	<b>Delay after event, sec</b>	User selectable	If After Event is selected, then the time between the end of the event to the beginning of the activation of the preset trigger can be configured
	<b>Pre-event, sec</b>	User selectable	If After Event is selected, duration of the pre-event
	<b>Post-event, sec</b>	User selectable	If After Event is selected, duration of the post-event
	<b>First trigger time, year</b>	User selectable	Date and time of the first trigger
<b>First trigger time, month</b>	User selectable		
<b>First trigger time, day</b>	User selectable		
<b>First trigger time, hour</b>	User selectable		
<b>First trigger time, minute</b>	User selectable		
<b>Total number of triggers</b>	User selectable	After reaching the configured number of triggers the preset trigger will not be activated anymore	
<b>Stored channels</b>	User selectable	Number of channels which should be stored into an event file in case of a trigger	
<b>List of stored channels</b>	<b>'+' and '-' can be used to change the preset triggers</b>		
	<b>Assigned channel name</b>	User selectable	Depending on the number of stored channels different sources can be selected. Select the source by pressing ' <b>A</b> '.

Table 7: Preset trigger configuration menu structure

## 9.7 File Storage and Policy

It can be configured in the instrument how all the files should be treated.

### 9.7.1 In the Web Interface or by GeoDAS

- Go to **Configuration** → **File Storage and Policy**

The screenshot shows the GeoSIG web interface. At the top, there is a navigation bar with 'Home', 'Configuration', 'Status and Maintenance', 'Data Explorer', 'Help', and 'Logout'. Below this, there are tabs for 'Data Acquisition', 'Configuration Manager', 'Network', and 'Web Interface'. The 'Configuration Manager' tab is active, showing a 'Main menu' with various settings. The 'File Storage and Policy' setting is highlighted with a red box. Below the settings, there are buttons for 'Back', 'Load from Device', 'Save Changes', and 'Apply and Restart'.

Main menu		
Station description	GeoSIG Station	
Station code	GSGMS	
Location description	Default location	
Seismic network code	GS	
Number of Channels	3	
Number of Output Streams	0	
Number of Trigger Sets	1	
Number of Preset Triggers	0	
Channel Parameters	>>	
Trigger Parameters	>>	
<b>File Storage and Policy</b>	<b>&gt;&gt;</b>	
Communication Parameters	>>	
Miscellaneous Parameters	>>	
Sensors and Virtual Channels	>>	
GeoSIG Options	>>	
Time synchronization	>>	

Buttons: Back, Load from Device, Save Changes, Apply and Restart

Figure 61: File Storage Settings

- Parameters for the following file types can be configured (see Filetypes in Table 8)
  - SOH - State of health information and requested data files
  - LOG - System log files
  - TRG - Events and PGM files
  - RBF - Ringbuffer files
  - MAN - Scheduled manual recordings
  - MSC - Miscellaneous files
- See Table 8 for more information about the parameters which can be configured.



### 9.7.2 Via Local Serial Console

```
Configuration
A) Station description ..... GeoSIG Station
B) Station code ..... GSGMS
C) Location description ..... Default location
D) Seismic network code ..... GS
F) Number of Output Streams ..... 1
G) Number of Trigger Sets ..... 1
H) Number of Preset Triggers ..... 1
I) Channel Parameters ..... ->
J) Stream Parameters ..... ->
K) Trigger Parameters ..... ->
L) Parameters of Preset Triggers ... ->
M) File Storage and Policy ..... ->
N) Communication Parameters ..... ->
O) Miscellaneous Parameters ..... ->
S) GeoSIG Options ..... ->
T) Time synchronization ..... ->
```

- To adjust the settings of the file storage, press **'M'**; the *File Storage and Policy* menu will appear.

```
Configuration | File Storage
A) System reserved space, Mb ..... 12 (0x0C)
B) Length of one RB file, minutes ... 10 (0x0A)
C) SOH and requested data files ..... ->
D) System log files ..... ->
E) Events and PGM files ..... ->
F) Ringbuffer files ..... ->
G) Scheduled manual recordings ..... ->
H) Miscellaneous files ..... ->
```

- Parameters for the following file types can be configured (see Filetypes in Table 8)
  - SOH - State of health information and requested data files
  - LOG - System log files
  - TRG - Events and PGM files
  - RBF - Ringbuffer files
  - MAN - Scheduled manual recordings
  - MSC - Miscellaneous files
- See Table 8 for more information about the parameters which can be configured.

	<b>System reserved space</b>	<i>User selectable</i>	Amount of memory reserved for the operating system in [Mb]. Keep <b>12 Mb</b> by default.
	<b>Length of one RB file</b>	<i>User selectable</i>	Permanent data will be stored in ringbuffer files; here the length of one ringbuffer file in minutes can be specified. After this time the file will be closed and a new one started.
<b>Filetypes</b>	<b>Disk space quota</b>	<i>User selectable</i>	Reserved memory on the SD/CF-Card for the SOH files in [%]
	<b>If over quota</b>	<b>Delete oldest files</b>	In case the reserved memory is full the oldest files will be deleted first
	<b>Life time</b>	<i>User selectable</i>	After the configured time in [days] the files will be deleted from the SD/CF-Card
	<b>Transfer priority</b>	<b>Never Transfer</b> <b>Low</b> <b>Mid</b> <b>High</b> <b>Highest</b>	In case a lot of files have to be transferred, the priority of the file upload can be configured here. If Never Transfer is configured, then no files will be uploaded.
	<b>Transfer order</b>	<b>Newest first</b> <b>Oldest first</b>	Most recent files are transferred first Most old files are transferred first
	<b>Delete transferred</b>	<b>Yes</b> <b>No</b>	Files will be deleted after upload to the server Files will be not deleted after upload to the server

Table 8: File Storage and Policies menu structure

- Additionally the system log files can be compressed. This can be separately enabled under the menu point D) *System log files*:

<b>Compress files</b>	<b>Yes</b> <b>No</b>	Files will be sent gzip-compressed (.gz) Original text files will be sent (default)
-----------------------	-------------------------	--

- State of health and event files have two more configuration options:

Transfer protocol	Standard (Custom)	Default option. This protocol also is used to transfer any other types of files.
	HTTPS	This option can be used to upload data files to the HTTPS servers only. Downloads are not supported.
Directory for uploads	User selectable	Name of the directory on the HTTPS server where uploaded files will be placed





## 9.8 Communication Parameters

This chapter explains how to set up the server parameters.

### 9.8.1 In the Web Interface or by GeoDAS

- Go to **Configuration** → **Communication Parameters**

The screenshot shows the GeoSIG web interface. At the top, there is a navigation bar with 'Home', 'Configuration', 'Status and Maintenance', 'Data Explorer', 'Help', and 'Logout'. Below this, there are tabs for 'Data Acquisition', 'Configuration Manager', 'Network', and 'Web Interface'. The 'Configuration Manager' tab is active, showing a 'Main menu' with various configuration options. The 'Communication Parameters' option is highlighted with a red box. Below the main menu, there are buttons for 'Back', 'Load from Device', 'Save Changes', and 'Apply and Restart'.

Main menu	
Station description	GeoSIG Station 
Station code	GSGMS 
Location description	Default location 
Seismic network code	GS 
Number of Channels	3
Number of Output Streams	0
Number of Trigger Sets	2
Number of Preset Triggers	0
Channel Parameters	>>
Trigger Parameters	>>
File Storage and Policy	>>
<b>Communication Parameters</b>	>>
Miscellaneous Parameters	>>
Sensors and Virtual Channels	>>
GeoSIG Options	>>
Time synchronization	>>

Buttons: Back, Load from Device, Save Changes, Apply and Restart

Figure 62: Communication Parameters

- Tick the flag **Contact remote servers** to configure a connection to a remote server.
- Configure the number of servers to contact in the field **Number of servers**
- Then go to **Server Parameters** to adjust the parameters as shown in the Table 9.
- In case the instrument should act as Server for other GMS instruments, tick the flag **Server mode for other instruments** and follow the steps as described in chapter 9.8.2.1

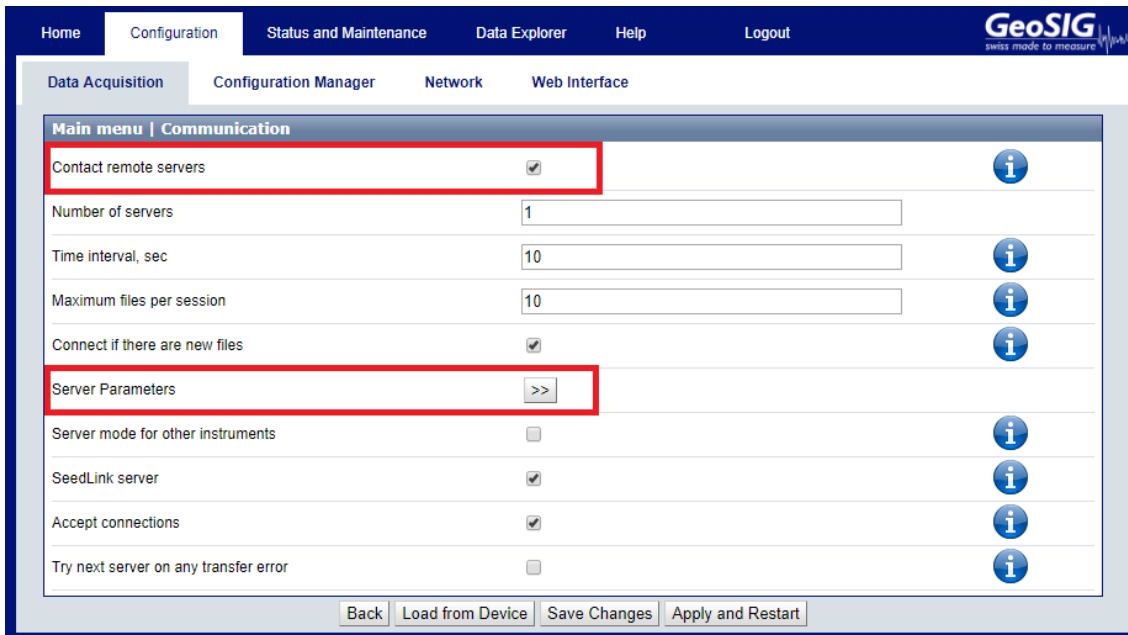

Figure 63: Edit Communication Parameters

### 9.8.2 Via Local Serial Console

```

Configuration
A) Station description ..... GeoSIG Station
B) Station code ..... GSGMS
C) Location description ..... Default location
D) Seismic network code ..... GS
E) Number of Channels ..... 3
F) Number of Output Streams ..... 1
G) Number of Trigger Sets ..... 1
H) Number of Preset Triggers ..... 0
I) Channel Parameters ..... ->
J) Stream Parameters ..... ->
K) Trigger Parameters ..... ->
M) File Storage and Policy ..... ->
N) Communication Parameters ..... ->
O) Miscellaneous Parameters ..... ->
S) GeoSIG Options ..... ->
T) Time synchronization ..... ->
    
```

- Press '**N**' to get to the *Communication Parameters* menu to adjust the settings of the file storage. The following menu appears:

```

Configuration | Communication
A) Contact remote servers ..... Yes
B) Number of servers ..... 1
C) Time interval, sec ..... 20 (0x14)
D) Maximum files per session ..... 10 (0x0A)
E) Connect if there are new files ..... Yes
G) Server Parameters ..... ->
H) Server mode for other instruments ... No
M) SeedLink server ..... Yes
N) Accept connections ..... Yes
    
```

- The following parameters can be adjusted:

	<b>Contact remote servers</b>	<b>Yes</b>	The instrument connects to the configured data server(s)
		<b>No</b>	The instrument does not connect to any data servers
	<b>Number of servers</b>	User selectable	Number of data servers. If the instrument cannot connect to the first data server it will connect to the second data server; if this one is down it connects to the third and so on. Scanning of servers stops after first successful connection.
	<b>Time interval, sec</b>	User selectable	Interval of connection to data servers in seconds
	<b>Maximum files per session</b>	User selectable	Maximum number of files, which will be uploaded during one session. Although data servers support concurrent connections, this parameter helps distributing the load of data processing by the server among several instruments.
	<b>Connect if there are new files</b>	<b>Yes</b>	Instrument connects to the server if there are new files recorded and ready to be transmitted.
		<b>No</b>	Instrument connects to the server if there are new files recorded and ready to be transmitted. Instrument does not connect to the server if there are new files. It just connects periodically as defined with the parameter <b>Time interval</b> .
<b>Server Parameters</b>	<b>Server IP Address</b>	User selectable	IP address of the data server
	<b>Protocol</b>	<b>Custom</b> <b>HTTPS</b>	Default protocol of communication This protocol can be selected only if you upload SOH and/or EVT files to HTTPS servers
	<b>Port</b>	User selectable	If Custom: Communication port of the data server
	<b>Transfer timeout, sec</b>	User selectable	Instrument gives up trying to contact the server after the configured timeout in seconds.
	<b>Network triggers</b>	<b>Yes</b>	Triggers are sent to the server for event detection as described in chapter <a href="#">C.2</a>
		<b>No</b>	Triggers are not sent to the server
	<b>Connect through PPP link</b>	<b>Yes</b>	Instrument connects to the data through PPP link
		<b>No</b>	Instrument does not connect to the data server through PPP
	<b>Number of failures to give up</b>	User selectable	Number of trials until giving up
	<b>Keep connected to the server</b>	<b>Yes</b>	Instrument connects to the data through PPP link
		<b>No</b>	
	<b>Server port for permanent links</b>	User selectable	The port which should be used to keep the connection between the server open
	<b>Always connect to this server</b>	<b>Yes</b>	Instrument will always try connecting to this server, even if a file has already been delivered to another server
<b>No</b>		Disable this function	
<b>Connect failures before network error</b>	User selectable	Number of failure before displays network error	

<b>Server mode for other instruments</b>	<b>Yes</b>	The instrument acts as a data server for other instruments. See chapter <a href="#">9.8.2.1</a> for more details	
	<b>No</b>	The instrument does not act as a data server.	
<b>Connect by requests from clients</b>	<b>Yes</b>	Instrument connects to the server if there are new files recorded and ready to be transmitted.	
	<b>No</b>	Instrument doesn't connect to the server if there are new files recorded and ready to be transmitted.	
<b>Port for incoming connections</b>	User selectable	Port for incoming connections. Other instruments have to set the same port under Server parameters	
<b>Secure authentication</b>	<b>Yes</b>	Secure authentication (SSL encryption) enabled.	
	<b>No</b>	Secure authentication (SSL encryption) disabled	
<b>Number of clients</b>	User selectable	Number of clients that this server can used	
<b>Clients Parameters</b>	'+' and '-' can be used to change between the servers		
	<b>Client IP Address</b>	User selectable IP of the client instrument which connects to this instrument.	
	<b>Client serial number</b>	User selectable Serial number of the client instrument. Use 000000 to allow instruments with any serial numbers to connect.	
	<b>Transfer timeout, sec</b>	User selectable Network timeout in seconds.	
	<b>Data forwarding</b>	<b>Yes</b>	Data from the data server will be forwarded to the client instruments and the other way round.
		<b>No</b>	Data will not be forwarded.
<b>Network triggers</b>	<b>Yes</b>	Triggers are sent to the server for event detection as described in chapter <a href="#">C.2</a>	
	<b>No</b>	Triggers are not sent to the server	
<b>SeedLink server</b>	<b>Yes</b>	SeedLink server is enabled for all data channels, and data streams can be received by any SeedLink client from the instrument's IP.	
	<b>No</b>	The instrument does not act as a Seedlink server.	
<b>Accept connections</b>	<b>Yes</b>	Allows GeoDAS to connect to the instrument. Works only if the IP address of the instrument is known and reachable.	
	<b>No</b>	Do not accept connections from new clients	
<b>Try next server on any transfer error</b>	<b>Yes</b>	If Yes, In case of communication error contact the next server out of the list of Configured Servers.	
	<b>No</b>	Don't try to contact the next server	

Table 9: Communication Parameters menu structure

### 9.8.2.1 Instrument acts in the Server Mode

The instrument can be configured to act as a server. In this case other instruments can upload their files to this instrument. The server-instrument can then forward the data to a main server by another communication medium. For example, two instruments (clients) upload their files to the instrument-server, which forwards the data to a GeoDAS server by the cellular modem.

The serial numbers and IP addresses of all client instruments must be configured in the server so that requests from GeoDAS can be correctly forwarded.



*This setup is not recommended, as it creates a big load for the server instrument. Special care must be taken during design and setup. Whenever possible, all instruments shall have a direct communication path to the GeoDAS server.*

<b>Server mode</b>		<b>Yes</b>	The instrument acts as a data server for other instruments
		<b>No</b>	The instrument does not act as a data server
<b>Port for incoming connections</b>		<i>User selectable</i>	Port for incoming connections. Other instruments have to set the same port under Server parameters.
<b>Secure authentication</b>		<b>Yes</b>	Secure authentication (SSL encryption) enabled
		<b>No</b>	Secure authentication (SSL encryption) disabled
<b>Client Parameters</b>	'+' and '-' can be used to change between the clients		
	<b>Client IP Address</b>	<i>User selectable</i>	IP address of the client instrument which connects to this instrument
	<b>Client serial number</b>	<b>Custom</b>	Serial number of the client instrument. Use 000000 to allow instruments with any serial numbers to connect
	<b>Transfer timeout</b>	<i>User selectable</i>	Network timeout in seconds
	<b>Data forwarding</b>	<b>Yes</b>	Data from the data server will be forwarded to the client instruments and the other way round.
		<b>No</b>	Data will not be forwarded
	<b>Network triggers</b>	<b>Yes</b>	Network triggers will be sent to the server
<b>No</b>		Network triggers will not be sent to the server	

Table 10: Server Parameters menu structure

## 9.9 Miscellaneous Parameters

The Baseline Correction, State of Health files, messaging and debugging can be adjusted under this menu.

### 9.9.1 In the Web Interface or by GeoDAS

- Go to **Configuration** → **Miscellaneous Parameters**

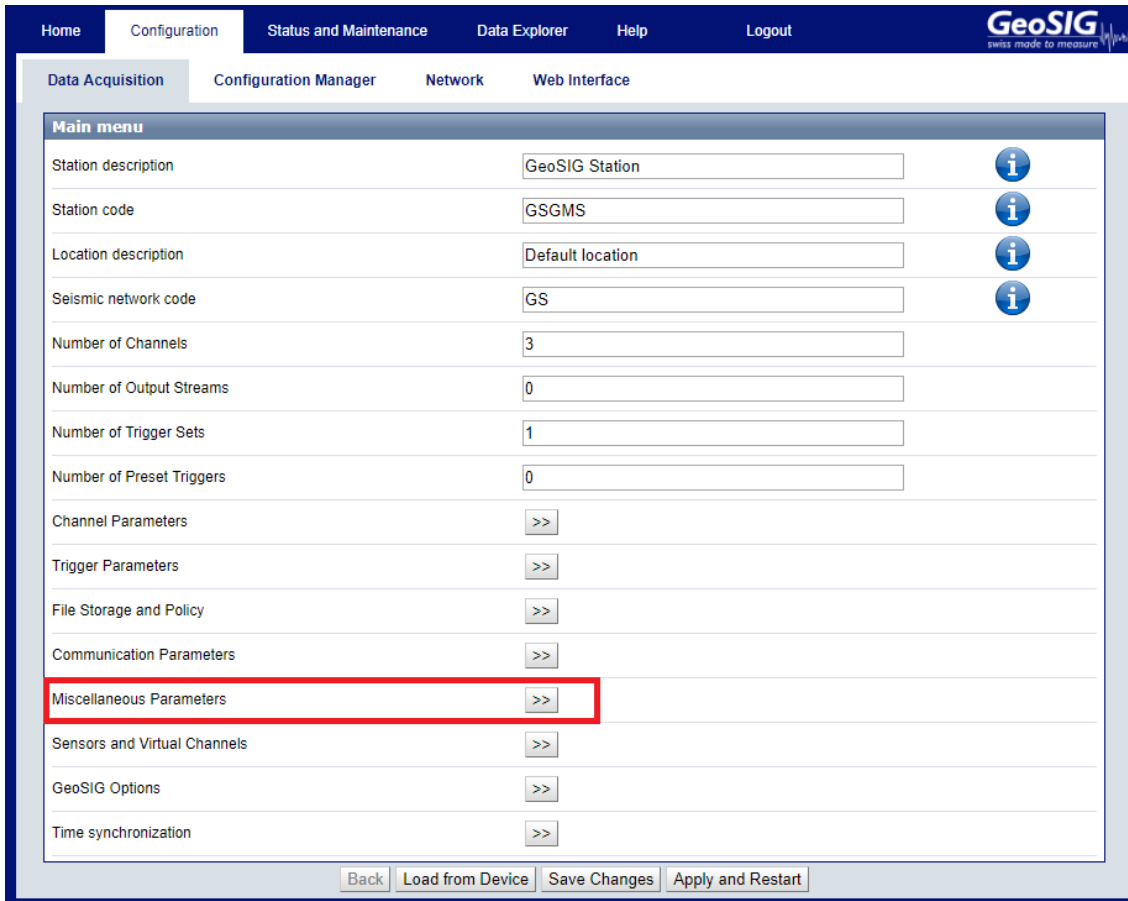

Figure 64: Miscellaneous Parameters



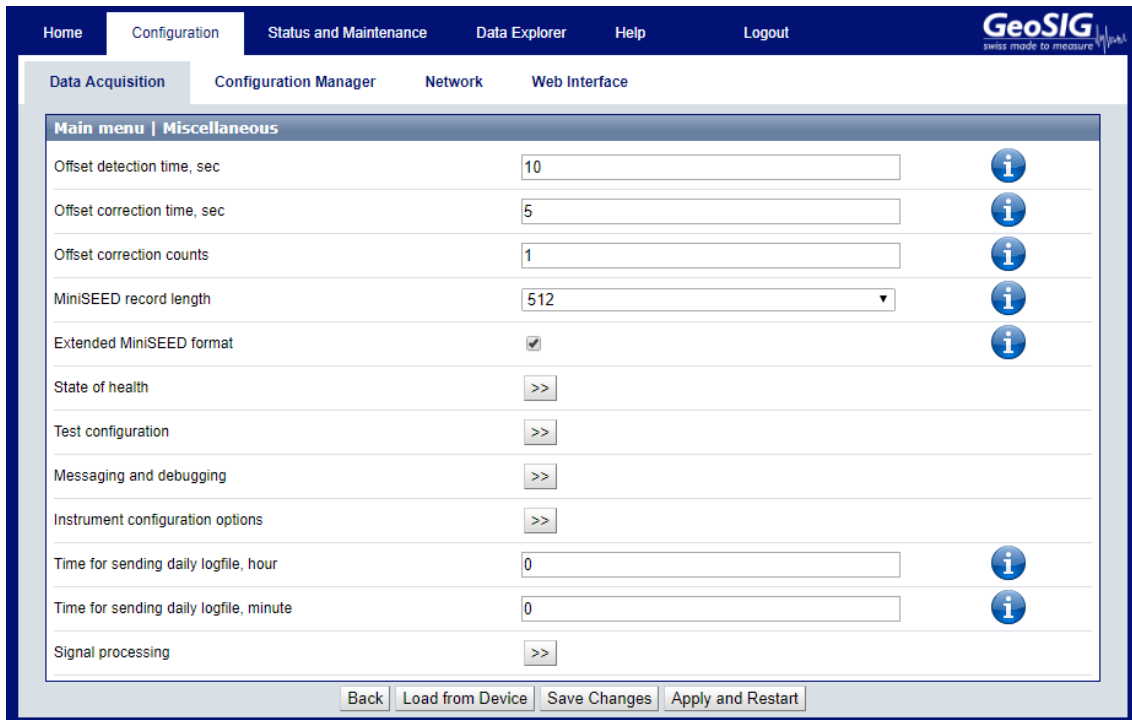

Figure 65: Edit Miscellaneous Parameters

Adjust the parameters as shown in the Table 11.

### 9.9.2 Via Local Serial Console

```

Configuration
A) Station description ..... GeoSIG Station
B) Station code ..... GSGMS
C) Location description ..... Default location
D) Seismic network code ..... GS
E) Number of Channels ..... 3
F) Number of Output Streams ..... 1
G) Number of Trigger Sets ..... 1
H) Number of Preset Triggers ..... 1
I) Channel Parameters ..... ->
J) Stream Parameters ..... ->
K) Trigger Parameters ..... ->
L) Parameters of Preset Triggers ... ->
M) File Storage and Policy ..... ->
N) Communication Parameters ..... ->
O) Miscellaneous Parameters ..... ->
S) GeoSIG Options ..... ->
T) Time synchronization ..... ->
    
```

- Press 'O' to get to the *Miscellaneous Parameters* menu to adjust time synchronisation, offset detection, and other settings. The following menu appears:

```

Configuration | Miscellaneous
A) Offset detection time, sec ..... 10 (0x0A)
B) Offset correction time, sec ..... 5 (0x05)
C) Offset correction counts ..... 1 (0x01)
D) MiniSEED record length ..... 512
E) Extended MiniSEED format ..... Yes
H) State of health ..... ->
I) Test configuration ..... ->
J) Messaging and debugging ..... ->
K) Instrument configuration options ..... ->
L) Time for sending daily logfile, hour ..... 0 (0x00)
M) Time for sending daily logfile, minute ... 0 (0x00)
S) Signal processing ..... ->
    
```

- The following parameters can be adjusted:

<b>Offset detection time, sec</b>	User selectable	Time in seconds, which the input values is measured after startup to define the offset. This 'static' offset will then compensate all channels with activated offset compensation.
<b>Offset correction time, sec</b>	User selectable	The instrument continuously takes the average over the number of seconds specified. If this value is positive it will subtract the number of Offset Correction Counts defined below. If the value is negative, the Offset Correction Counts will be added to the signals. This is only active for channels where the offset compensation is activated and is used to compensate 'dynamic' offset which changes over time (E.g. because of temperature changes).
<b>Offset correction counts</b>	User selectable	The number of counts which will be added to the signal, respectively removed from the signal, depending on the signum of the continuously calculated average over the Offset Correction Time
<b>MiniSEED record length</b>	User selectable	Length of one data block inside the miniSEED file. In most applications, the default value 512 shall be kept.
<b>Extended MiniSEED format</b>	<b>No</b>  <b>Yes (default)</b>	MiniSEED files do not include any additional information. This option shall be used only if you face any problems in reading extended format of miniSEED files with your customized software.  MiniSEED files include configuration and state of health information, which is encapsulated into the blockettes 2000. When you open such files with GeoDAS, there is no need to enter LSB factors and units. This feature is supported from GeoDAS version 2.21.
Include SOH information in miniSEED	<b>Yes</b>	Include SOH information in each MiniSEED file as Blockette 2000 record.
	<b>No (default)</b>	Do not include SOH information in each MiniSEED file as Blockette 2000 record.
Include configuration in miniSEED	<b>Yes</b>	Include current config.xml information in each MiniSEED file as Blockette 2000 record
	<b>No (default)</b>	Do not include current config.xml information in each MiniSEED file as Blockette 2000 record

<b>State of health</b>	<b>SOH report type</b>	<b>None</b> <b>Standard</b>	No SOH file will be created SOH files will be created and uploaded to the server according to the settings in chapter 9.7
	SOH reporting interval, days	User selectable	If Standard selected, defines the interval between the SOH reports in days, hours and minutes
	SOH reporting interval, hours	User selectable	
	SOH reporting interval, minutes	User selectable	
	<b>Time of the first SOH report</b>	<b>Startup</b> <b>Random</b> <b>User defined</b>	First SOH report will be created at startup Time of the first SOH is random. This is to avoid all instruments using the network at the same time. First SOH report will be created at the user defined time.
	<b>First SOH report time, hours</b>	User selectable	If <i>User defined</i> is selected, defines the hour and minute of the first SOH report
	<b>First SOH report time, minutes</b>	User selectable	
	<b>Activate alarm on errors or</b>	<b>Yes</b> <b>No</b>	Activates an alarm relay in case of an error. Alarm relay will not be activated in case of an error.
	<b>Activate alarm when system is inactive</b>	<b>Yes</b> <b>No</b>	Alarm relay is activated in case armdas is not running. Alarm relay will not be activated.
	<b>Error and inactivity alarm output</b>	<b>AL1</b> <b>AL2</b> <b>AL3</b> <b>AL4</b>	Select the alarm relay if at least one of the condition above is <b>Yes</b>

<b>State of health (continued)</b>	<b>Activate alarm on errors</b>	<b>Yes</b>	Alarm relay is activated in case armdas is not running.
		<b>No</b>	Alarm relay will not be activated.
	<b>Activate alarm on selected error only</b>	<b>Yes</b>	Selected alarm relay is activated on selected errors only. See below options
		<b>No</b>	Selected alarm relay is activated on all errors.
	<b>Alarm on file-system errors</b>	<b>Yes</b>	Enable the alarm of filesystem errors
		<b>No</b>	Disable the alarm of filesystem errors
	<b>Alarm on memory errors</b>	<b>Yes</b>	Enable the alarm of memory errors
		<b>No</b>	Disable the alarm of memory errors
	<b>Alarm on timing errors</b>	<b>Yes</b>	Enable the alarm of timing errors
		<b>No</b>	Disable the alarm of timing errors
	<b>Alarm on DSP errors</b>	<b>Yes</b>	Enable the alarm of DSP errors
		<b>No</b>	Disable the alarm of DSP errors
	<b>Alarm on network errors</b>	<b>Yes</b>	Enable the alarm of network errors
		<b>No</b>	Disable the alarm of network errors
<b>Alarm on disk errors</b>	<b>Yes</b>	Enable the alarm of disk errors	
	<b>No</b>	Disable the alarm of disk errors	
<b>Alarm on aux errors</b>	<b>Yes</b>	Enable the alarm of aux errors	
	<b>No</b>	Disable the alarm of aux errors	
<b>Alarm on processing errors</b>	<b>Yes</b>	Enable the alarm of processing errors	
	<b>No</b>	Disable the alarm of processing errors	
<b>Alarm on misc hardware errors</b>	<b>Yes</b>	Enable the alarm of misc hardware errors	
	<b>No</b>	Disable the alarm of misc hardware errors	
<b>Monitor state of current loop sensors</b>	<b>Yes</b>	It monitors the sensor offset for its valid range. If sensor offset is outside of its valid range a sensor failure error message will be issued.	
	<b>No</b>	Disable the monitor state of the current loop sensor	
<b>Send SOH on changing error state</b>	<b>Yes</b>	Enable send SOH on changing error state.	
	<b>No</b>	Disable send SOH on changing error state	
<b>Send SOH on changing warning state</b>	<b>Yes</b>	Enable send SOH on changing warning state	
	<b>No</b>	Disable send SOH on changing warning state	

<b>Test Configuration</b>	<b>Type of periodic sensor test</b>	<b>None</b> <b>Pulse</b>	No test pulse is generated Test pulse is generated periodically and automatically, depending on the following settings
	<b>Sensor test interval, days</b>	User selectable	Interval between two sensor tests
	<b>Time of the first test</b>	<b>Startup</b>	First test will be done at start-up, next after the defined interval.
		<b>Random</b>	Time of the first test is random. This is to avoid, that all instruments in a network are doing the test in exactly the same moment and are not able to record events normally at the same time.
		<b>User defined</b>	First test will be done at the user defined time.
	<b>First test report time, hours</b>	User selectable	If <i>User defined</i> is selected, defines the hour and minute of the first test report
	<b>First test report time, minutes</b>	User selectable	
	<b>Activate alarms on sensor test</b>	<b>Normal</b>	An alarm is activated only if an amplitude of the test pulse is above the related threshold.
		<b>Never</b>	The alarms are not activated on tests
		<b>Always</b>	An alarm is activated upon every test.
<b>Record test files</b>	<b>Normal</b>	A file is recorded only if an amplitude of the test pulse is above the trigger threshold.	
	<b>Never</b>	Test files are not recorded	
	<b>Always</b>	A file is recorded upon every test.	
<b>Prefix for names of test files</b>	<b>CAL_</b> <b>TRG_</b>	Test files will be created with this prefix	

	<b>Console messages</b>	<b>Yes</b>	Enable console message
		<b>No</b>	Disable console message
	<b>Debug: memory allocation</b>	<b>Yes</b>	Enable debug message: memory allocation
		<b>No</b>	Disable debug message: memory allocation
	<b>Debug: system and processes</b>	<b>Yes</b>	Enable debug message: system and processes
		<b>No</b>	Disable debug message: system and processes
	<b>Debug: flash memory</b>	<b>Yes</b>	Enable debug message: flash memory
		<b>No</b>	Disable debug message: flash memory
	<b>Debug: configuration</b>	<b>Yes</b>	Enable debug message: configuration
		<b>No</b>	Disable debug message: configuration
	<b>Debug: network links</b>	<b>Yes</b>	Enable debug message: network links
		<b>No</b>	Disable debug message: network links
	<b>Debug: data streams</b>	<b>Yes</b>	Enable debug message: data streams
		<b>No</b>	Disable debug message: data streams
	<b>Debug: data sources</b>	<b>Yes</b>	Enable debug message: data sources
		<b>No</b>	Disable debug message: data sources
	<b>Debug: ring buffers</b>	<b>Yes</b>	Enable debug message: ring buffers
		<b>No</b>	Disable debug message: ring buffers
	<b>Debug: event triggers</b>	<b>Yes</b>	Enable debug message: event triggers
		<b>No</b>	Disable debug message: event triggers
	<b>Debug: time synchronisation</b>	<b>Yes</b>	Enable debug message: time synchronisation
		<b>No</b>	Disable debug message: time synchronisation
	<b>Debug: file manager</b>	<b>Yes</b>	Enable debug message: file manager
		<b>No</b>	Disable debug message: file manager
	<b>Debug: cryptographic info</b>	<b>Yes</b>	Enable debug message: cryptographic info
		<b>No</b>	Disable debug message: cryptographic info
	<b>Debug: hardware related info</b>	<b>Yes</b>	Enable debug message: hardware related info
		<b>No</b>	Disable debug message: hardware related info
	<b>Debug: external hardware</b>	<b>Yes</b>	Enable debug message: external hardware
		<b>No</b>	Disable debug message: external hardware
	<b>Debug: JMA early warning</b>	<b>Yes</b>	Enable debug message: JMA early warning
		<b>No</b>	Disable debug message: JMA early warning
<b>Instrument configuration options</b>	<b>Enable autodetection of the instrument</b>	<b>Yes</b>	Instrument can automatically be found by GeoDAS in the LAN.
		<b>No</b>	Instrument can not automatically be found by GeoDAS.

	<b>Time for sending daily logfile, hour</b>	User selectable	If transfer is activated as described in chapter 8.7, the daily logfile will be sent to the server at this hour of the day. This can be adjusted to avoid that all instruments send the logfile at exactly the same time
	<b>Time for sending daily logfile, minute</b>	User selectable	
	<b>Keep modem always powered</b>	<b>Yes</b>	Keep the external cell modem always powered
		<b>No</b>	Turning it on only when required
	<b>Startup time for cellular modem</b>	User selectable	Time the system will wait for the Cellular modem to start up
	<b>Connect time for cellular modem</b>	User selectable	Time the system will wait for the Cellular modem to connect to the provider
<b>Signal processing</b>	<b>DSP mode set delay [s]</b>	User selectable	After startup, the instruments internal clock is roughly synchronized against a foreign network time source (NTP) and time is pushed to the DSP. During this initial time period the DSP will use this foreign time to do sampling while synchronizing to an external time-source such as GPS. After this initial time period the DSP will be switch to the external time-source.
	<b>DSP sync behaviour</b>	<b>Dilate</b>	The DSP is supposed to drift against to correct time, i.e., an offset of the reported and actual time is noted in each record of the mini-seed file. No interruptions of waveform processing occurs but it can take some hours until synchronization has been completed. This mode is ideal for building monitoring.
		<b>Wrap</b>	Upon switchinhg the time-source, the DSP stops waveform processing, re-synchronizes the ADC clocks and restarts waveform processing. This mode is only recommended when long drift times are undesirable.
	<b>DSP snap window [ms]</b>	User selectable	Specifies the maximum allowed time difference the DSP can drift to obtain synchronization with an external time-source, in case the instrument was running for a long period of time on its internal RTC, e.g., after GPS failure. If the time difference between the DSPs internal clock and the external time source is larger than the specified amount, the DSP will perform a time-warp and waveform processing will be restarted.
	<b>Waveform processing style</b>	<b>Slow</b>	Once per second waveform processing is executed which allows sampling rates as low as 1 SPS.
<b>Standard</b>		This is the default mode on all GeoSIG instruments and supports sampling rates as low as 5 SPS.	
<b>Real-time</b>		The scheduler guarantees an execution rate of 50 times per second for waveform processing making this mode ideal for applications in the early warning field.	

Table 11: Miscellaneous Parameters menu structure

## 9.10 Time synchronization

### 9.10.1 In the Web Interface or by GeoDAS

- Go to **Configuration** → **Time synchronization**

The screenshot shows the GeoSIG Configuration Manager interface. The top navigation bar includes 'Home', 'Configuration', 'Status and Maintenance', 'Data Explorer', 'Help', and 'Logout'. The 'Configuration' tab is active, and the 'Web Interface' sub-tab is selected. The main menu lists various configuration options, with 'Time synchronization' highlighted by a red box. Below the main menu are buttons for 'Back', 'Load from Device', 'Save Changes', and 'Apply and Restart'.

Main menu		
Station description	<input type="text" value="GeoSIG Station"/>	
Station code	<input type="text" value="GSGMS"/>	
Location description	<input type="text" value="Default location"/>	
Seismic network code	<input type="text" value="GS"/>	
Number of Channels	<input type="text" value="3"/>	
Number of Output Streams	<input type="text" value="0"/>	
Number of Trigger Sets	<input type="text" value="1"/>	
Number of Preset Triggers	<input type="text" value="0"/>	
Channel Parameters	<input type="button" value="&gt;&gt;"/>	
Trigger Parameters	<input type="button" value="&gt;&gt;"/>	
File Storage and Policy	<input type="button" value="&gt;&gt;"/>	
Communication Parameters	<input type="button" value="&gt;&gt;"/>	
Miscellaneous Parameters	<input type="button" value="&gt;&gt;"/>	
Sensors and Virtual Channels	<input type="button" value="&gt;&gt;"/>	
GeoSIG Options	<input type="button" value="&gt;&gt;"/>	
<b>Time synchronization</b>	<input type="button" value="&gt;&gt;"/>	

Figure 66: Time synchronization Parameters

Adjust the parameters as shown in the Table 12.



Main menu   Time Synchronization		
Time source	AUTO	
NTP server 1	0.pool.ntp.org	
NTP server 2	1.pool.ntp.org	
NTP server 3	2.pool.ntp.org	
NTP server 4	3.pool.ntp.org	
NTP server query interval, sec	60	
NTP requests in a row	4	
NTP query intervals per RTC update	1	
NTP synchronisation timeout warning, min	240	
NTP synchronisation timeout error, hours	12	
NTP maximum error, sec	0.1	
GPS reception timeout, min	30	
GPS check interval in NTP mode, min	60	
GPS check duration in NTP mode, sec	120	
RTC watchdog timeout, sec	1200	
Send SOH upon RTC status change	<input type="checkbox"/>	
Offset to UTC, minutes	120	
Use IANA timezone mapping	<input checked="" type="checkbox"/>	
Use ISO timestamp formatting	<input checked="" type="checkbox"/>	

Back Load from Device Save Changes Apply and Restart

Figure 67: Edit Time synchronization Parameters

### 9.10.2 Via Local Serial Console

```

Configuration
A) Station description ..... GeoSIG Station
B) Station code ..... GSGMS
C) Location description ..... Default location
D) Seismic network code ..... GS
E) Number of Channels ..... 3
F) Number of Output Streams ..... 1
G) Number of Trigger Sets ..... 1
H) Number of Preset Triggers ..... 1
I) Channel Parameters ..... ->
J) Stream Parameters ..... ->
K) Trigger Parameters ..... ->
L) Parameters of Preset Triggers ... ->
M) File Storage and Policy ..... ->
N) Communication Parameters ..... ->
O) Miscellaneous Parameters ..... ->
S) GeoSIG Options ..... ->
T) Time synchronization ..... ->
    
```

- Press '**T**' to get to the *Time synchronization* menu to adjust the time synchronisation parameters. The following menu appears:

Configuration   Time Synchronization	
A) Time source	AUTO
B) NTP server 1	0.pool.ntp.org
C) NTP server 2	1.pool.ntp.org
D) NTP server 3	2.pool.ntp.org
E) NTP server 4	3.pool.ntp.org
F) NTP server query interval, sec	60 (0x3C)
G) NTP requests in a row	4 (0x04)
H) NTP query intervals per RTC update	1 (0x01)
I) NTP synchronisation timeout warning, min	240 (0xF0)
J) NTP synchronisation timeout error, hours	12 (0x0C)
K) NTP maximum error, sec	0.1
L) GPS reception timeout, min	30 (0x1E)
M) GPS check interval in NTP mode, min	60 (0x3C)
N) GPS check duration in NTP mode, sec	120 (0x78)
O) RTC watchdog timeout, sec	1200 (0x4B0)
P) Send SOH upon RTC status change	No
S) Offset to UTC, minutes	120
T) Use IANA timezone mapping	Yes
U) Use ISO timestamp formatting	Yes

<b>Time source</b>	<b>RTC</b>	RTC is not synchronizing itself to any source. It will keep it's own time which might differ from other devices or the actual time.
	<b>GPS</b>	RTC is synchronising to the, optionally, connected GPS, which allows very good time synchronisation between devices with other GPS enabled devices.
	<b>NTP</b>	RTC is synchronising to a NTP server.
	<b>AUTO</b>	RTC synchronises to NTP in case GPS is not available. This is a good option for GPS and Ethernet enabled devices, where the GPS reception might be lost from time to time.
	<b>NET1PPS</b>	RTC is synchronizing to the 1PPS signal. This signal can be received by the optional 433 MHz wireless module or the interconnection network. (This option needs a device which is broadcasting its time by 433 MHz.)
<b>NTP server 1</b>	User selectable	IP of the primary NTP Server.
<b>NTP server 2</b>	User selectable	IP of the secondary NTP Server.
<b>NTP server query interval, sec</b>	User selectable	Interval time in seconds the NTP server is contacted by the instrument.
<b>NTP requests in a row</b>	User selectable	Every time the instrument is contacting the NTP server the configured number of requests will be sent. For service and advanced user only, only change the default value if you know what you are doing.
<b>NTP query intervals per RTC update</b>	User selectable	Specifies the number of NTP synchronizations until the RTC is updated. The default is to update the RTC after each synchronization with a NTP server.
<b>NTP synchronisation timeout warning, min</b>	User selectable	Raise a warning if synchronization with the NTP server was not possible for the given amount of time. Default is 240minutes.

<b><i>NTP synchronisation timeout error, hours</i></b>	User selectable	Raise an error if synchronization with the NTP server was not possible for the given amount of time. Default is 12hours.
<b><i>NTP maximum error, sec</i></b>	User selectable	If the current RTC time differs more than this time limit in [seconds] from the NTP time, the RTC time will make a time jump to the NTP time. Otherwise the time will be tuned slowly. For service and advanced user only, only change the default value if you know what you are doing
<b><i>GPS reception timeout, min</i></b>	User selectable	If GPS signal is lost, after this time in [minutes] the RTC will change its synchronisation method to NTP
<b><i>GPS check interval in NTP mode, min</i></b>	User selectable	If the time synchronisation is in the 'Auto" mode, and the RTC is synchronized to the NTP (because the GPS signal has been lost) the instruments checks in the configured interval if the GPS is available again (minutes)
<b><i>GPS check interval in NTP mode, sec</i></b>	User selectable	If the time synchronisation is in the 'Auto" mode, and the RTC is synchronized to the NTP (because the GPS signal has been lost) the instruments checks for the configured time duration if the GPS is available again (seconds))
<b><i>RTC watchdog timeout, sec</i></b>	User selectable	If armdas is not running for this amount of time, there will be a hard reset of the device. Only change this setting if you really know what you are doing! Wrong settings could render your device unusable without GeoSIG support. The value of 0 disables the Watchdog.
<b><i>Send SOH upon RTC status change</i></b>	<b>Yes</b>	In case RTC status changes, a SOH message will be uploaded to the server.
	<b>No</b>	In case RTC status changes, no SOH will be send
<b><i>Offset to UTC, minutes</i></b>	User selectable	Difference between the local time and Coordinated Universal Time (UTC). The default is to use UTC as time reference.
<b><i>Use IANA timezone mapping</i></b>	<b>Yes</b>	Use Time Zone to set instrument time
	<b>No</b>	Don't use Time Zone to set instrument time
<b><i>Use ISO timestamp formatting</i></b>	<b>Yes</b>	Use ISO 8601 in all files name including offset
	<b>No</b>	Don't use ISO 8601 in all files name including offset

Table 12: Time Synchronization Parameters Menu Structure

The system has a Real Time Clock (RTC) that maintains internal time when the unit is turned off. During normal operation the RTC is responsible for providing the most accurate time possible to the system and performing time synchronization with other available external time sources as:

- GPS time code receiver on the GPS interface
- NTP (Network Time Protocol) server from the wired or wireless Ethernet interface

It also keeps under control the sampling clock of the ADCs and self-calibrates its oscillator against temperature and aging when it is connected with an accurate external time signal.

The DSP receives a continuous 1 PPS signal from the RTC with the best possible accuracy of the RTC, including temperature compensation, based on the saved coefficients. The DSP will sync the sampling clock with this 1 PPS signal to have accurate sample timing.

#### 9.10.2.1 Temperature compensation

RTC uses the internal temperature sensor of the micro-controller to define the current operating temperature. When good time synchronization occurs, typically using a GPS, the RTC checks its own drift against the signal of the GPS and adds the correction coefficients in a trim table. With a NTP time source, the accuracy is worse but the same process occurs with more averaging and on longer period of time.

During factory test, all the coefficients are initialized to the room temperature coefficient using a GPS. After installation on site, the unit will learn the correction parameters according to the ambient conditions at site and also according to the aging of the oscillator.

## 9.11 GeoSIG Options



This menu and the functions under it are subject to change. The user should not use or rely on any features under this menu without consulting GeoSIG.

### 9.11.1 Via Local Serial Console

```

Configuration
A) Station description ..... GeoSIG Station
B) Station code ..... GSGMS
C) Location description ..... Default location
D) Seismic network code ..... GS
E) Number of Channels ..... 3
F) Number of Output Streams ..... 1
G) Number of Trigger Sets ..... 1
H) Number of Preset Triggers ..... 1
I) Channel Parameters ..... ->
J) Stream Parameters ..... ->
K) Trigger Parameters ..... ->
L) Parameters of Preset Triggers ... ->
M) File Storage and Policy ..... ->
N) Communication Parameters ..... ->
O) Miscellaneous Parameters ..... ->
S) GeoSIG Options ..... ->
T) Time synchronization ..... ->
    
```

- Press **'S'** to get to the *GeoSIG Options* menu to enter Product key for EEW applications, enable/disable and configure waveform injection and other GeoSIG specific features.

```

Main Menu | GeoSIG Options
A) Enable real-time waveform message queue ... No
B) Product Key (required for early warning) ... XXXXX-XXXXX-XXXXX-XXXXX-XXXXX
C) Waveform Simulator ..... ->
    
```

- The following parameters can be adjusted:

<b>Enable real-time waveform message queue</b>		<b>Yes</b>	Enable the real-time waveform message queue.
		<b>No</b>	Disable the real-time waveform message queue.
<b>Product Key (required for early warning)</b>		User selectable	If purchased, enter the product key for early warning options. The product key is of the form XXXXX-XXXXX-XXXXX-XXXXX.
<b>Waveform Simulator</b>	<b>Enable waveform source</b>	User selectable	Enable waveform inject from files (0...disable, 1...first file, 2...second file, 3...third file.
	<b>Source 1</b>	User selectable	Path for first waveform source.
	<b>Source 2</b>	User selectable	Path for second waveform source.
	<b>Source 3</b>	User selectable	Path for third waveform source.

Table 13: GeoSIG options menu structure

## 9.12 Other Options in the Instrument Main Menu

Next to the edit of the instrument configuration, there are other actions possible from the main menu shown below:

```

Main menu:
C - Configuration ->
M - Messages ->
X - Display errors (0) and warnings (0)
W - Clear errors and warnings
T - File statistics
I - System information ->
S - Shell command
U - Control requests ->
R - Restart firmware
Z - Reboot instrument
Q - Quit
    
```

	Action or command	Description
<b>C</b>	<b>Configuration</b> →	Change of the configuration of the instrument. See chapter 9 for details.
<b>M</b>	<b>Messages</b> →	Possible to configure what kind of messages are shown in the console.
<b>X</b>	<b>Display errors (n) and warnings (m)</b>	Shows present errors and warnings.
<b>W</b>	<b>Clear errors and warnings</b>	Clears all errors and warnings.
<b>T</b>	<b>File statistics</b>	Displays information about files and the memory usage.
<b>I</b>	<b>System information</b> →	Displays information about the status of the instrument.
<b>S</b>	<b>Shell command</b>	Allows executing a Linux shell command from <i>armdas</i> . For advanced users only.
<b>U</b>	<b>Control requests</b> →	See chapter 9.12.1 for details.
<b>R</b>	<b>Restart</b>	Restarts the instrument, e.g. after a change of the configuration.
<b>Z</b>	<b>Restart</b>	Reboots the instrument.
<b>Q</b>	<b>Quit</b>	Stops <i>armdas</i> data acquisition and exits to the Linux console. For advanced users only.

Table 14: Other options in the main menu

### 9.12.1 Control Requests

Several actions can be initiated by the user:

- In the main menu press **'U'** to enter the Control requests menu.

```
Main menu:  
C - Configuration ->  
M - Messages ->  
X - Display errors (0) and warnings (0)  
W - Clear errors and warnings  
T - File statistics  
I - System information ->  
S - Shell command  
U - Control requests ->  
R - Restart firmware  
Z - Reboot instrument  
Q - Quit
```

- Type the letter of the request you want to execute from the list below:

```
Data requests, triggering:  
A - Request N seconds of ringbuffer data, starting from the indicated date and time  
B - Activate manual trigger to start recording  
C - Deactivate manual trigger  
  
Status and information:  
D - Generate SOH file with the current state-of-health information  
E - Force uploading current logfile to a server  
F - Enable debug log messages, see the manual for details  
G - Disable debug log messages, see the manual for details  
  
Service and recovery:  
H - Set date and time of the last transferred file to the indicated ones  
I - Erase the entire data storage. Use it as a last resort!  
J - Make hardware reboot of the instrument  
K - Reset errors and warnings of the instrument  
L - Retrieve trim table values  
M - Reset trim table  
N - Calibrate temperature correction using current temperature Tcur in C  
O - Make current configuration as the user default one  
P - Reset to the user default configuration  
Q - Delete one group of files or all files  
R - Date and time settings  
8 - Halt the system for manual power off  
  
Sensor test and calibration:  
V - Generate a sensor test pulse  
W - Remove offsets from signals  
  
Direct request:  
X - Exit, run the package manager, upgrade and reboot  
Y - Initiate hotswap of storage media  
Z - Send user request  
  
Simulation and testing:  
[ - Run pre-configured seismic event  
  
Select <A>...<W>. <Esc> to exit
```

- See details in Table 15

Letter	Request	Description
<b>Data requests, triggering:</b>		
A	GETEVT YYYY-MM-DD HH:MM:SS N	The instrument creates an event with the length of N seconds from the ringbuffer data, starting from the indicated date and time and uploads the data to the server if configured (see chapter 9.8).
B	TRIGGERNOW [trigger_name]	Activate a manual trigger to start recording, the manual trigger must be configured as described in the chapter 9.6
C	STOPTRIGGER [trigger_name]	Deactivates the manual trigger
<b>Status and information:</b>		
D	GETSOH	The instrument generates a SOH file with the current state-of-health information and uploads to the server if configured (see chapter 9.8).
E	GETLOG	The instrument uploads today's logfile to the server.
F	SETMSG flags	Enables/disables debug log messages. For service only, do not change
G	CLRMSG flags	
<b>Service and recovery:</b>		
H	LASTDT YYYY-MM-DD HH:MM:SS	Set date and time of the last transferred file  The instrument saves the date and time of the latest uploaded file and will not upload any file which is created before this date and time. Under normal conditions this will be never the case. But if the time is changed backwards by the user - e.g. from 10:00 to 06:00 - the instrument will not upload any data till 10:00 again. So the time of the last transferred file can be adjusted here and should be set to 06:00 in this example.
I	FORMAT	Formats the data storage media. <b>All data will be lost, and instrument will be restarted.</b>
J	REBOOT	Performs full reboot of the instrument
K	RESETERR	Reset errors and warnings of the instrument
L	GETTRIM	The instrument will upload a SOH file containing the actual values from the RTC trim table. The latest SOH file can be found under <code>\\Geo-DAS_DATA\\StatusFiles\\InfoSOH.xml</code>
M	CLEARTRIM	The instrument will clear the RTC trim table
N	TCAL <Tcur>	Calibration of the internal temperature sensor by applying the actual temperature in °C. The RTC uses temperature to learn.



O	SETDEF CFG	Makes the current instrument configuration as user default one. Whenever you change parameters of the instrument, they are saved in the non-volatile instrument memory as Current Configuration, and used to set all parameters of the data acquisition at startup. But if due to some reason the current configuration gets corrupted, and GMS cannot load or cannot process it, the Default Configuration file, which is created by this command, will be used instead. Note that Default Configuration is compiled from the actual parameters of the running system, and therefore it is already approved by GMS and is supposed to be correct. Thus, we recommend sending this command to the instrument after you are sure that your GMS is started with the latest configuration correctly and everything works as expected.  The default configuration can also be set and restored in the Web Interface, see chapter 8.3.2
P	RSTUSRDEF	Reset the instrument to its user default configuration.
Q	DELETE <file_prefix or ALL> [YYYY-MM-DD [HH:MM]]	Delete one group of files or all groups of files from the compact flash card. One can request to delete only files that are older than the specified date (and optionally time).
R		Enter the Date and time settings. The Main battery installation date and the current RTC date and time can be changed from this submenu.
8	Halt the system	Halt the instrument for the manual device power off .
<b>Sensor test and calibration:</b>		
V	TSTSENSOR 1 [REC=TRG YES NO] [ALARM=TRG YES NO]	The instrument generates a sensor test pulse. Optional parameters REC and ALARM specify whether a file will be recorded during test and whether an alarm will be generated in case an alarm board is present. Parameters TRG, YES and NO correspond to the modes Normal, Always and Never described in the section 9.9.2
W	REMOVEDC	Remove offsets from signals
<b>Direct request:</b>		
X		For service and advanced user only.
Y		For service and advanced user only.
Z		For service and advanced user only.
<b>Simulation and testing:</b>		
[		For service and advanced user only.

Table 15: Control requests

In case the instrument has a Seismometer Control Board installed, then additionally the following user requests are possible under *Sensor test and calibration*:

SLOCK	Performs a mass locking of the connected seismometer
SUNLOCK	Performs a mass unlocking of the connected seismometer
SCENTRE	Perform a mass centring of the seismometer



*The above requests can also be sent from GeoDAS by choosing 'Send a Request' from the 'GMS Communication Interface' or from Web Interface from the menu State of Health → Requests . See chapters [C.3.4](#) and [8.4.5](#) for details.*

## 10 Test and Configuration Menu

The test and configuration menu can only be accessed locally at the instrument over the serial cable.

- Switch on the instrument by pressing and holding the POWER button for 2 seconds.
- Press **<Ctrl> + 'Z'** as soon as the following message appears on the console to enter the test and configuration mode:

```
Press Ctrl+Z to enter the test mode.....
```

- The test and configuration menu has three access levels.

Level	Shortcut	Password	Description
User	Ctrl+U	None	Basic operations only
Powerful User	Ctrl+W	None	Also hardware options and pre-selected tests
Administrator	Ctrl+A	None	Also manual tests and altering the FLASH memory content

Your level [U/W/A] or press B to boot now:

The test and configuration menu has three access levels as outlined above: User, Powerful User and Administrator, and each level can be protected by a password. Instead of pressing **<Ctrl>+'Z'**, one can press **<Ctrl>+'U'**, **<Ctrl>+'W'** or **<Ctrl>+'A'** to bypass the above messages and to proceed directly to a menu of the desired level. The Administrator has access to the most complete menu but the majority of functions are not used for the standard instrument operation, and therefore they are not described here in detail. The useful options are highlighted and described below.

```
Access level: User

--- Flash Images and Boot Options ---
L - List flash images
Q - Reset instrument configuration to the user default
V - Reset instrument configuration to the factory default
5 - Boot now
X - Reboot the instrument
Y - Power off

--- Hardware Setup and Monitor ---
N - Network settings

--- Security ---
0 - Set password

-->
```

Access level: **Powerful User**

```
--- Flash Images and Boot Options ---  
L - List flash images  
Q - Reset instrument configuration to the user default  
V - Reset instrument configuration to the factory default  
5 - Boot now  
X - Reboot the instrument  
Y - Power off  
  
--- Hardware Setup and Monitor ---  
K - Instrument hardware parameters  
N - Network settings  
T - Battery installation dates  
  
--- Security ---  
0 - Set password  
J - Reset all passwords  
  
-->
```

Access level: **Administrator**

```
--- Flash Images and Boot Options ---  
L - List flash images  
Q - Reset instrument configuration to the user default  
V - Reset instrument configuration to the factory default  
5 - Boot now  
X - Reboot the instrument  
Y - Power off  
  
--- Hardware Setup and Monitor ---  
K - Instrument hardware parameters  
N - Network settings  
T - Battery installation dates  
  
--- Test Functions ---  
P - Test RTC  
M - Test GPS  
  
--- Security ---  
0 - Set password  
J - Reset all passwords  
  
-->
```

## 10.1 Flash Images and Boot Options

<b>L</b>	<b>List flash images</b>	Lists all the current firmware in the image
<b>Q</b>	<b>Reset instrument configuration to the user default</b>	Forces the instrument to load the user default configuration. See description of the command SETDEF CFG in the chapter <a href="#">9.12.1</a>
<b>V</b>	<b>Reset instrument configuration to the factory default</b>	Forces the instrument to load the factory default settings
<b>5</b>	<b>Boot from the default image</b>	Exits the test and configuration menu and starts the instrument normally
<b>X</b>	<b>Reboot the instrument</b>	Forces the watchdog to completely restart the instrument
<b>Y</b>	<b>Power off</b>	Forces the watchdog to switch off the instrument

## 10.2 Hardware Setup and Monitor

<b>K</b>	<b>Instrument hardware parameters</b>	Checks what HW is installed in the instrument and adjust the number of sensors
<b>N</b>	<b>Network settings</b>	Enters the menu to adjust the network settings (dynamic or fixed IP, subnet and gateway, DNS servers), the PPP settings, enable/disable the SSH and Web Interface and configure the backup server. For details see chapter <a href="#">5.2</a>
<b>T</b>	<b>Battery installation dates</b>	Whenever you install a new battery, you must set the installation dates using this menu.

## 10.3 Test Functions

<b>P</b>	<b>Test RTC</b>	Runs an automatic check of the RTC
<b>M</b>	<b>Test GPS</b>	Allows user to see the NMEA messages of the GPS and to initialise the GPS receiver.

## 10.4 Security

<b>O</b>	<b>Set password</b>	Sets the password to prevent unauthorised access to the current level of the test and configuration menu.
<b>J</b>	<b>Reset all passwords</b>	Resets all passwords below the levels of access

- Leave the test and configuration menu by pressing **'5'** or **'Y'**

## 10.5 Comparison of User Permissions

	User	Powerful User	Administrator
<b>Flash Images and Boot Options</b>			
List Flash images	X	X	X
Reset instrument configuration to the user default	X	X	X
Reset instrument configuration to the factory default	X	X	X
Boot now	X	X	X
Reboot the instrument	X	X	X
Power off	X	X	X
<b>Hardware Setup and Monitor</b>			
Instrument hardware parameters		X	X
Network settings	X	X	X
Battery installation dates		X	X
<b>Test Functions</b>			
Test RTC			X
Test GPS			X
<b>Security</b>			
Set password	X	X	X
Reset passwords		X	X

Table 16: Comparison of test and configuration menu users

## 11 Firmware Upgrade

All the firmware for

- Linux operating system
- armdas firmware
- DSP
- SUP

can be upgraded by the user by using GeoDAS as described in the following chapters. The firmware will be released only as a complete package, containing all the firmware listed above. Please see [www.geosig.com](http://www.geosig.com) → **Support** → **Downloads** to download the latest firmware release package.

- ☞ *Even if there is no known case of data loss during the upgrade, we recommend backing up all recorded data and the configuration before starting the upgrade.*
- ☞ *After any firmware upgrade, the configuration and the correct function of the instrument should be fully verified.*

If the instruments are configured to contact a server, it is possible to upgrade all or specific instruments remotely using GeoDAS. Before trying to upgrade remotely, be sure the instruments have a working network connection to the server. To proceed with the firmware upgrade, please take the following steps:

- Make a right click on the Station in the GeoDAS main window and select **Instrument Control...**

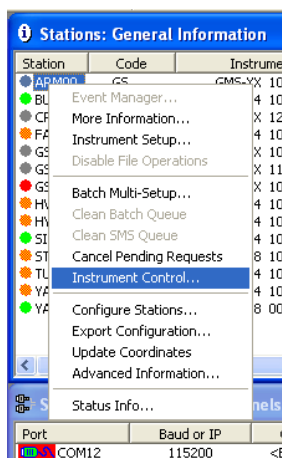

Figure 68: Select Instrument Control

- A list box will appear.

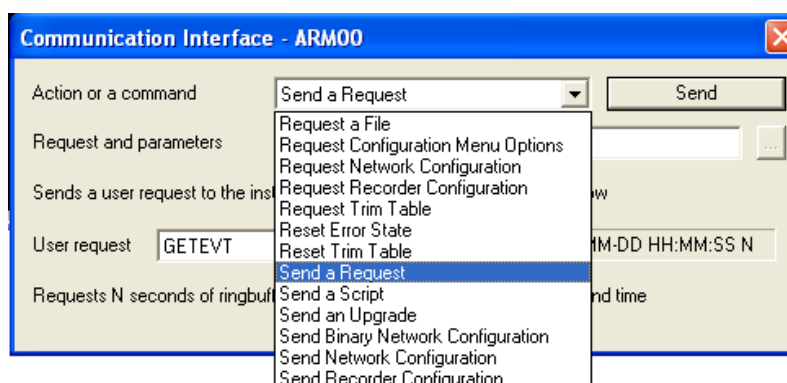
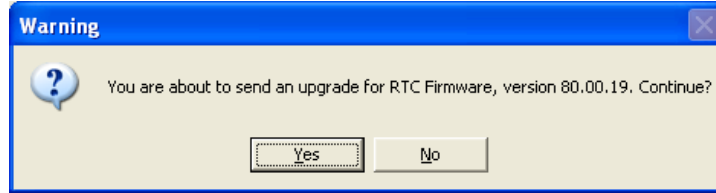

Figure 69: instrument Communication Interface

- Select the item Send an Upgrade
- Press on the button Browse ... to select the required firmware. Select a firmware container with the extension \*.*gsfw* or a \*.*zip* archive containing several update packages.
- If the file is selected, press the **Send** button. GeoDAS identifies the firmware and asks for confirmation. Please double check that the correct firmware has been selected.



- Upon pressing the **Yes** button, the firmware will be placed in the Outgoing directory, so that it can be collected by the instrument(s) upon next connection.

Station	Code	Instrument	Channel Type	Status Updated	Files	Free Memory	Last Event	Voltage	Current Activity
SS000	DEMO_	GMS-XX	TCP: 192.168.10.80	13.10.2010 at 19:08:38	0 (0)	971940K (98...	27.09.2010...	AC, DC...	Not connected. Pending: DSP_100210_20101014_072658.hex

Figure 70: Pending upgrade on the server

- As soon as the instrument has downloaded the new firmware, the text *Pending: xxx.gsfw* disappears. The instrument will verify the firmware and once the upgrade process is finished, the instrument will restart.

When the instrument software receives such a file it checks the actual version and, only if the file contains more recent firmware than the existing one, it will start the upgrade. After the upgrade, the new firmware will be in "trial" mode and a reboot is done. If the reboot and instrument operation is correct, the new firmware will be accepted. If the instrument reboots through its watchdog because the firmware was faulty, the previous firmware version will be used and the system will be restored to its state before the upgrade.

Downgrades to the older firmware versions might be required in some specific cases. This is possible, too. Please contact GeoSIG support for the exact procedure of such downgrade.



# Appendices

## Appendix A Connector Pinouts

### A.1 POWER Connector

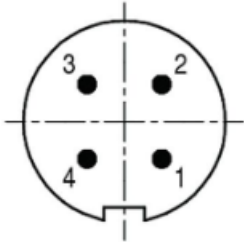

Pin	Description	Wire color	Function
1	GND	WHITE	Power return for external device
2	DEV_PWR	BROWN	External device power supply, 5 or 12 [VDC]
3	EXT_GND	GREEN	Power return
4	_EXT_SUP+	YELLOW	Positive power input, 9 to 48 [VDC]

Mating Type: Binder 423 Series, cable connector female, 4 pole

### A.2 ETHERNET Connector

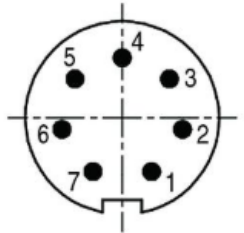

Pin	Description	Function
1	N/C	Not connected
2	_ETH_RX_P	Ethernet receive data +
3	_ETH_RX_N	Ethernet receive data -
4	_ETH_TX_P	Ethernet transmit data +
5	_ETH_TX_N	Ethernet transmit data -
6	_ETH_POE_P	Power over Ethernet +
7	_ETH_POE_N	Power over Ethernet -

Mating Type: Binder 423 Series, cable connector female, 7 pole

### A.3 ALARM Connector

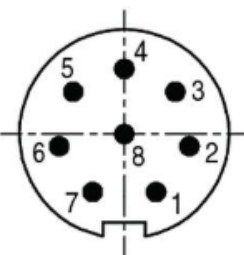

Pin	Description	Wire Color	Function
1	ALARM1(NO)	WHITE	ALARM1 Normally opened
2	ALARM1(CMN)	BROWN	ALARM1 Common
3	ALARM2(NO)	GREEN	ALARM2 Normally opened
4	ALARM2(CMN)	YELLOW	ALARM2 Common
5	AKN+	GRAY	AKNOWLEDGE Signal + / Input Voltage: 15 [VDC]
6	AKN-/GND	PINK	AKNOWLEDGE Signal -
7	SUPPLY	RED	Power Supply 15 [VDC]
8	GND	BLUE	Power Return Path

Mating Type: Binder 423 Series, cable connector female, 8 pole



**The maximum load is limited at 60VDC and 500mA. Higher voltages or current will permanently damage the device.**

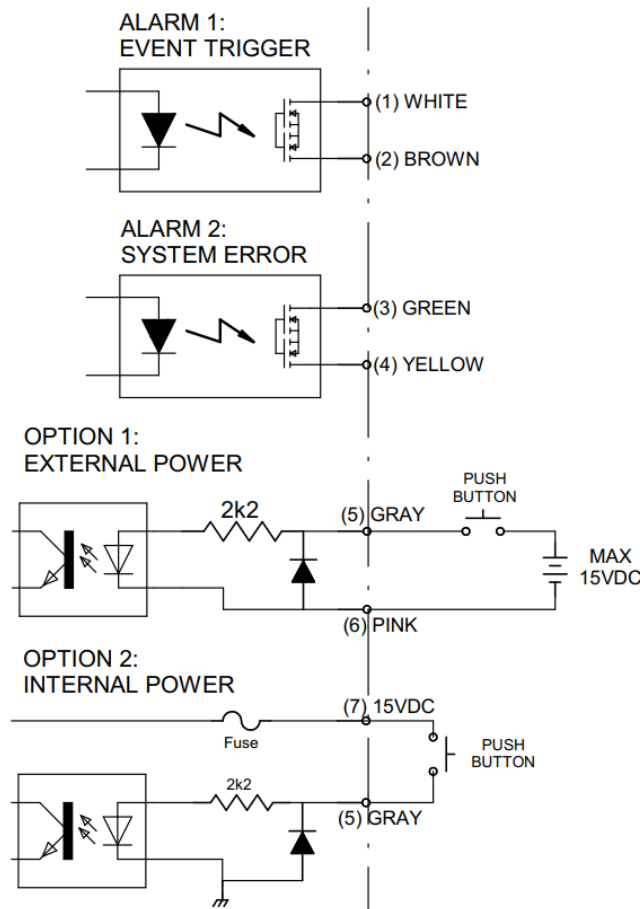
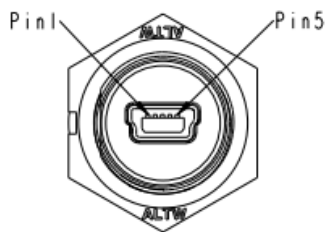

Figure 71: Alarms wiring diagram

## A.4 CONSOLE Connector



Pin	Description	Function
1	CONS_VB	USB Power Supply (VBUS)
2	CONS_D-	USB data -
3	CONS_D+	USB data +
4	GND	USB power return (GND)
5	N/C	Not connected

Mating Type: Amphenol LTW Series, cable connector male, 5 pole

## Appendix B Remote Access to the Instrument over SSH

 | **The following chapter is for advanced users only.**  
**Warranty will be void if something is damaged by user during changes in the root file system.**

Secure Shell (SSH) is a network protocol for secure data communication, remote shell services or command execution and other secure network services between two networked computers that it connects via a secure channel over an insecure network: a server and a client (running SSH server and SSH client programs, respectively).

 | *The armdas console cannot be shown through the SSH. This is a limitation of the armdas firmware.*

The instrument supports all types of remote access through SSH. User can connect from his PC by SSH client program to the SSH server of the instrument. Simple SSH client program can be used for this purpose. Use root as login and swiss as the password, as shown:

Login: **root**  
Password: **swiss**

Sign '#' is a command prompt where you can type console commands.

The password can be changed by **passwd** command.

 | **Warranty will be void in case password is changed and forgotten.**

### B.1 SSH Clients for Linux OS

For the Ubuntu or other Debian-like GNU/Linux OS, SSH client program, with command line interface, can be installed by command

```
$ sudo apt-get install openssh-client
```

To login into the instrument console, "ssh root@192.168.1.10" command can be issued from any terminal emulator as following figure shows:



Figure 72: Command line SSH client at terminal emulator

Alternatively, the PuTTY SSH client with GUI interface can be installed by command

```
$ sudo apt-get install putty
```

This software can be found in a menu **Applications** → **Internet** → **PuTTY SSH Client** and its configuration dialog looks like:

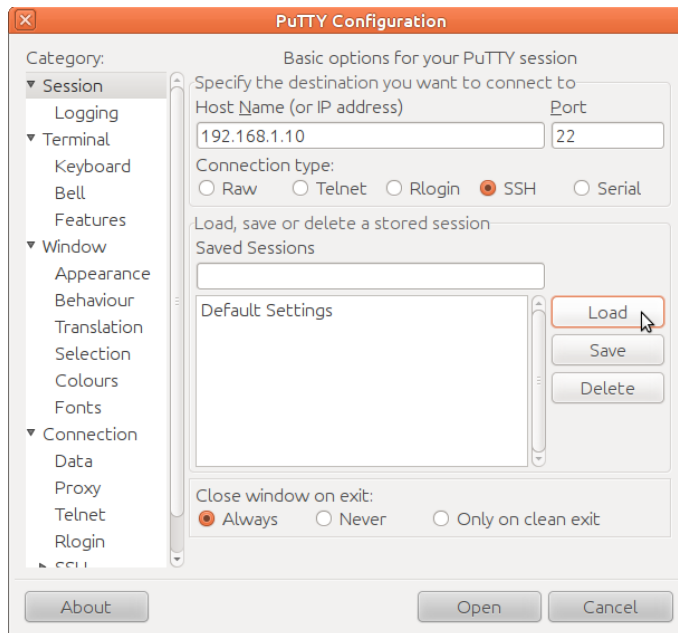

Figure 73: Configuration window of PuTTY

IP address 192.168.1.10 from examples above should be changed to the real IP address of the instrument.

## B.2 SSH Clients for Windows OS

The same PuTTY as for GNU/Linux OS or alternatively TeraTerm software can be used for Windows OS to have remote access to the instrument by means of SSH.

Its connection window is shown below



Figure 74: TeraTerm Connection Window

The PuTTY software for Windows OS operates the same as PuTTY for Linux OS.

The PuTTY software can be downloaded from <https://www.chiark.greenend.org.uk/~sgtatham/putty/>

The TeraTerm software can be downloaded from <http://tssh2.osdn.jp/>

### B.3 SFTP access for Windows OS

WinSCP is an open source free SFTP client for Windows. Its main function is the easy file transfer between a local computer and the instrument.

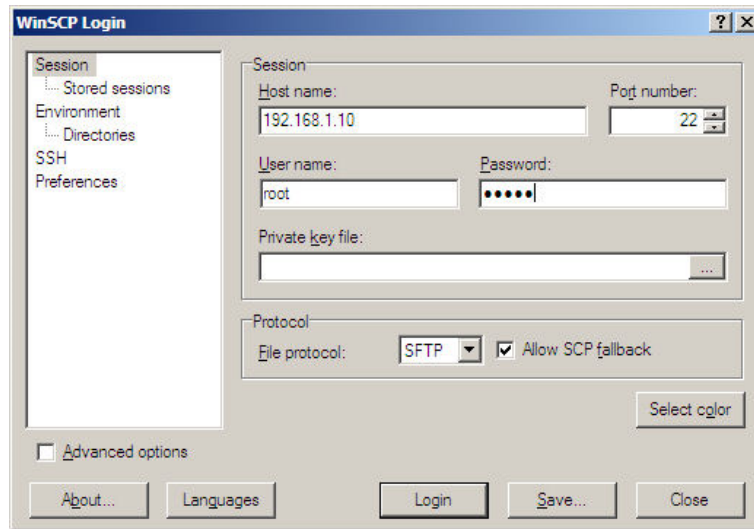

Figure 75: WinSCP login window

To connect to the instrument put the IP address of the GMSela and enter the following user name and password:

Login: **root**  
Password: **swiss**

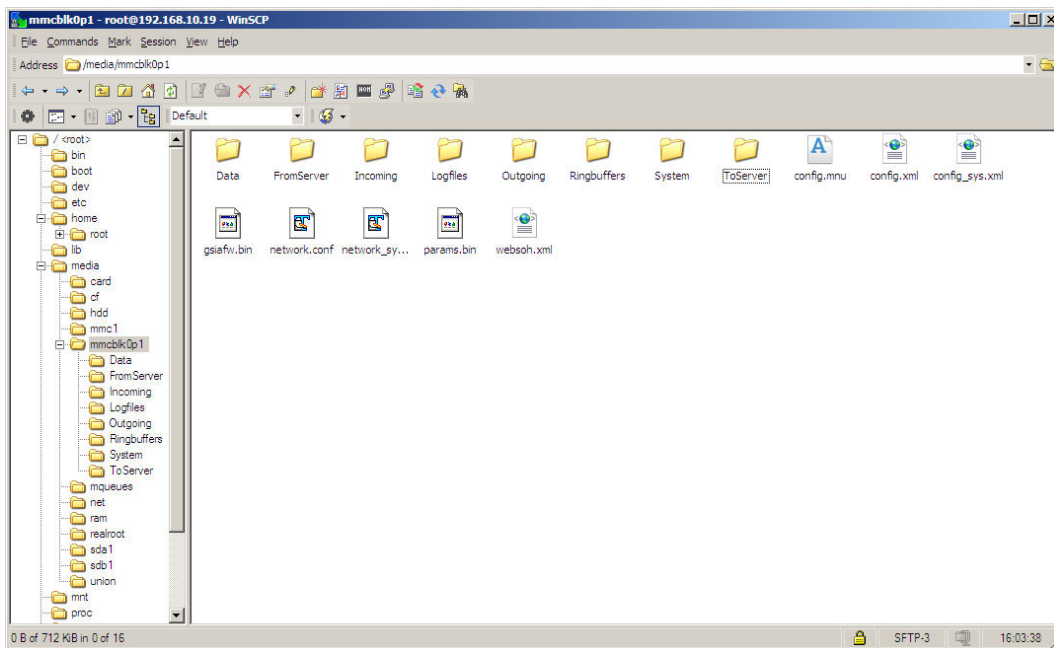

Figure 76: Explorer mode of WinSCP when connected to the instrument

It is then possible to browse through the available data on the instrument and copy files from or to the computer. The file structure is described in the following chapter.

The WinSCP can be downloaded from here: <https://winscp.net/eng/download.php>

## B.4 File Structure of the Instrument

On the instrument the files are organized as following

\media\mmcblk01\...	in case an SD card is installed
...Data\	Event files
...Ringbuffers\	Permanent recording files
...Logfiles\	Log files of armdas

The filenames contain the following information

<b>XXX_SNSNSN_YYYYMMDD_HHMMSS.ext</b>		
	Extension	<b>.ext</b> Depending on file type
		<b>.msd</b> MiniSEED containing waveform data
		<b>.xml</b> SOH and PGM information
		<b>.txt</b> LOG and ERR files
		<b>.bin</b> MMA packets (special for Korean market)
	Time	<b>HH</b> Hour
		<b>MM</b> Minutes
		<b>SS</b> Seconds
	Date	<b>YYYY</b> Year
		<b>MM</b> Month
		<b>DD</b> Day
	S/N	<b>SNSNSN</b> Six digit serial number of instrument
	Type	<b>XXX</b> Depending on file type
		<b>TRG</b> Event trigger
		<b>USR</b> User request
		<b>TTT</b> Time table trigger
		<b>CAL</b> File with test pulse
		<b>MAN</b> Manual trigger
		<b>RBF</b> Permanent recording
		<b>LOG</b> Log files
		<b>SOH</b> State of Health information
		<b>PGM</b> PGM information of event
		<b>ERR</b> Error messages

## Appendix C GeoDAS Settings

### C.1 Configuration of Stations

To be able to communicate with the instrument, GeoDAS must act as a server. This chapter should help to find the correct settings.

- Open GeoDAS and Go to the menu **Settings** → **Configure Stations...** , the following window will appear:

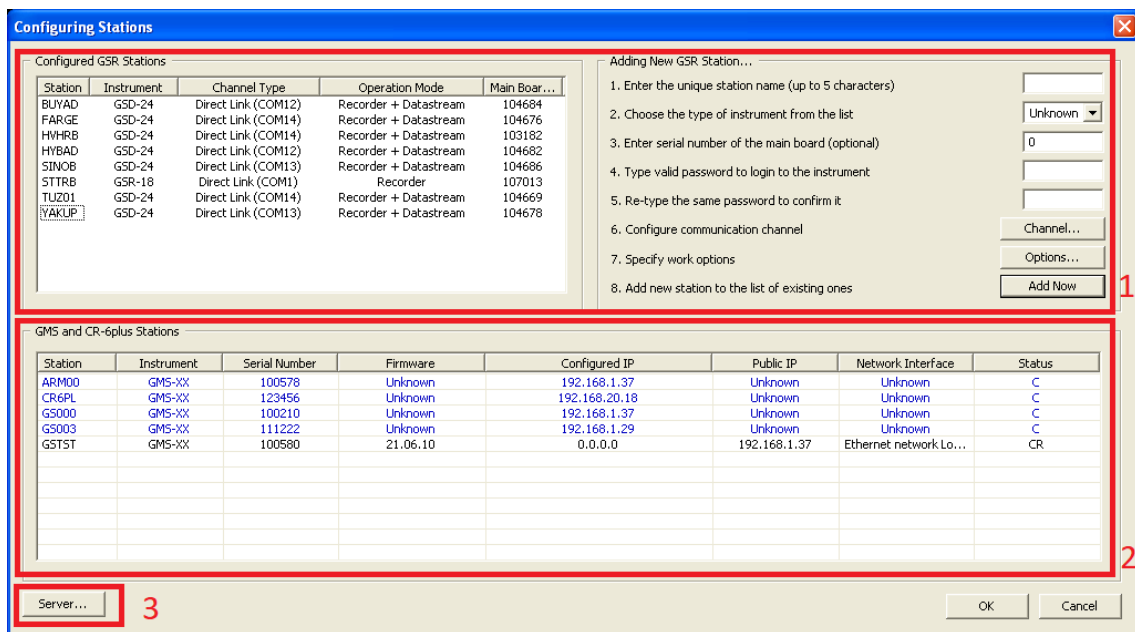

Figure 77: Configuration Stations

Area	Topic	Description
1	Configured GSR Stations	Details about the configured GSR-xx and GCR-xx stations. Check separate <i>GeoDAS Manual</i> for details.
2	Instrument Stations	<p>Details about the configured instruments. All instruments connected to the same network will be listed in grey.</p> <p><b>Station</b> name can be changed by a double click on the field you want to change.</p> <p>The column <b>Instrument</b> and <b>Serial Number</b> shows the instrument type and its serial number.</p> <p>The <b>Firmware</b> column shows the firmware version of the main data acquisition firmware.</p> <p>The <b>Public IP</b> shows from where the instrument is connected to the server. In case the instrument is behind a router or firewall, then this IP address will be shown. Network settings can be done according to chapter 7. If one wants to connect manually to the instrument, then GeoDAS will try the address and port listed under <b>Address</b>.</p> <p>The last column in the table is <b>Status</b>, which is indicated by one or more letters, which are the following:</p> <ul style="list-style-type: none"> <li>• N - New instrument</li> <li>• C - already Configured earlier</li> <li>• A - Altered parameters</li> <li>• R - actual settings were Received from the instrument</li> </ul>
3	Server Settings	For configuration of the Server, see chapter C.2



### C.1.1 Add a new Instrument

All instruments connected to the same network will be listed in grey. To add one of these stations into the current configuration do the following:

- Select the instrument and make a **right click**
- Click on **Add Station to Current Configuration**
- Press **OK**

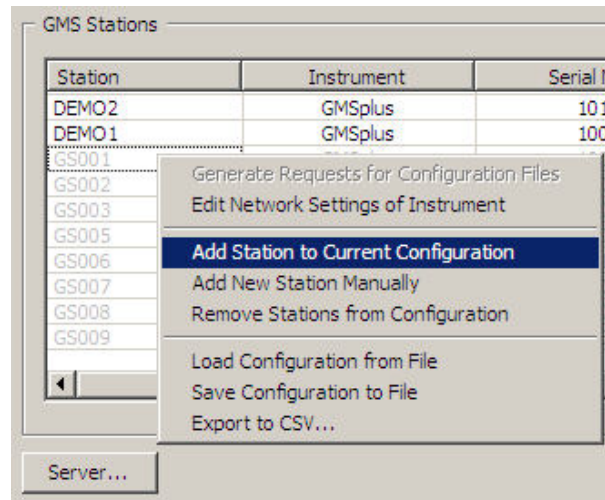

Figure 78: Add Station to Current Configuration

If the instrument is not in the local network and cannot directly be accessed, then press **Add New Station Manually** and enter the serial number of the instrument.

### C.1.2 Remove an Instrument

To remove one of the stations of the current configuration do the following:

- Select the instrument and make a **right click**
- Click on **Remove Station from Configuration**
- Press **OK**

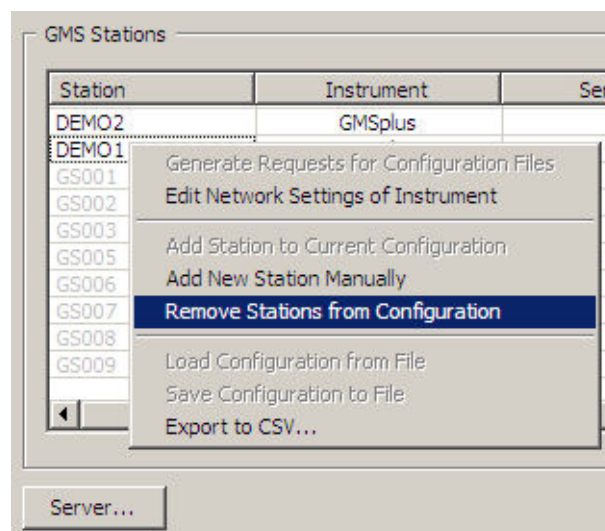

Figure 79: Remove Station from Current Configuration

For more details please see *GeoDAS Manual*.

## C.2 Configuration of Server Parameters

- Press the button **Server...**, the window below appears:

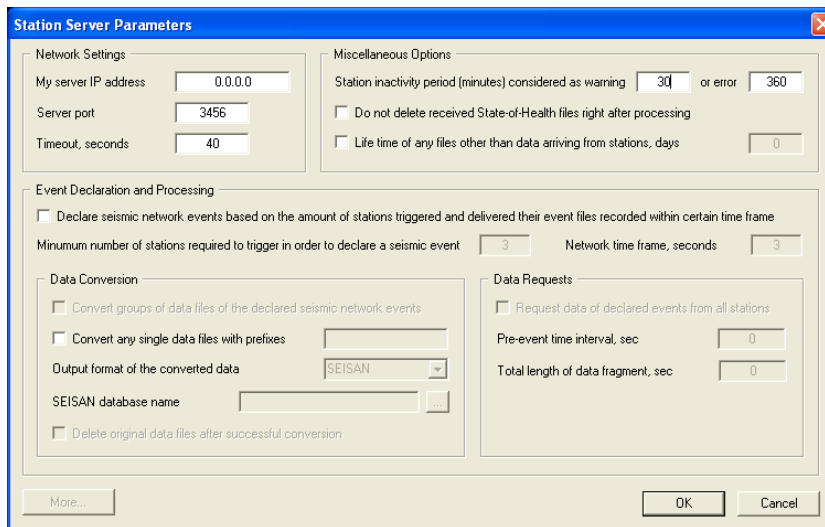

Figure 80: Station server parameters

Group of Controls	Description
Network Settings	<b>IP address and port</b> of the server, i.e. computer which GeoDAS is running on as well as the network <b>Timeout</b> in seconds. If server has several network interfaces but connections from instruments are expected from only one of them, then its IP address must be specified. Otherwise, leave it zero, which means that GeoDAS accepts incoming connection at any interface. The timeout is used to decide when to terminate current network connection if the remote party does not respond within the indicated time interval.
Miscellaneous Options	<b>Network error</b> is declared if an instrument did not communicate with GeoDAS within the indicated period of time. Make sure that this parameter is higher than the communication interval set in the instrument as described in chapter 9.8  If <b>State-of-health forwarding interval</b> is set to nonzero value, then SOH reports are collected within this period of time and only then are forwarded. You can also choose not to delete SOH reports after processing. If this option is selected, all received state of health reports remain in the directory <code>\\GeoDAS_DATA\\StatusFiles\\InfoSOH</code>
Event Detection	GeoDAS can be instructed to analyse event data files received from configured instruments to see if they belong to the same earthquake and to declare an event if it is so. You need to enable the option <b>Declare and process triggers of seismic network</b> in order to do so.  A network event is declared if at least <b>Minimum number of stations triggered</b> within the <b>Network time frame</b> . Received event files can be converted to Seisan format and stored in Seisan database on the same computer.
Customised Data Processing	This is not a standard feature of GeoDAS. Therefore please check the GeoDAS Manual and contact GeoSIG for further details if you need to use this functionality.

### C.3 Instrument Control in GeoDAS

By making a right click on the station name in the window *Stations: General Information*, several options become available to control and check the instrument. See the figure below:

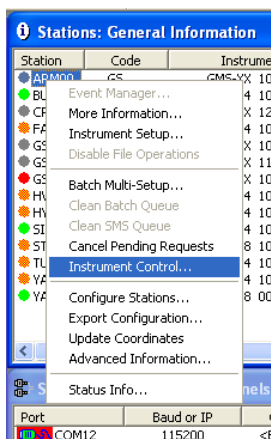

Figure 81: Instrument control of the station in GeoDAS

#### C.3.1 More Information... (State of Health of the Instrument)

The status of the instruments can be easily checked if the instrument is set up to transfer periodically the SOH file to the server. (See details about SOH configuration in chapter 8.4 and 9.8).

- Make right click on the Station in the GeoDAS main window and select **More Information...**, the following window will appear:

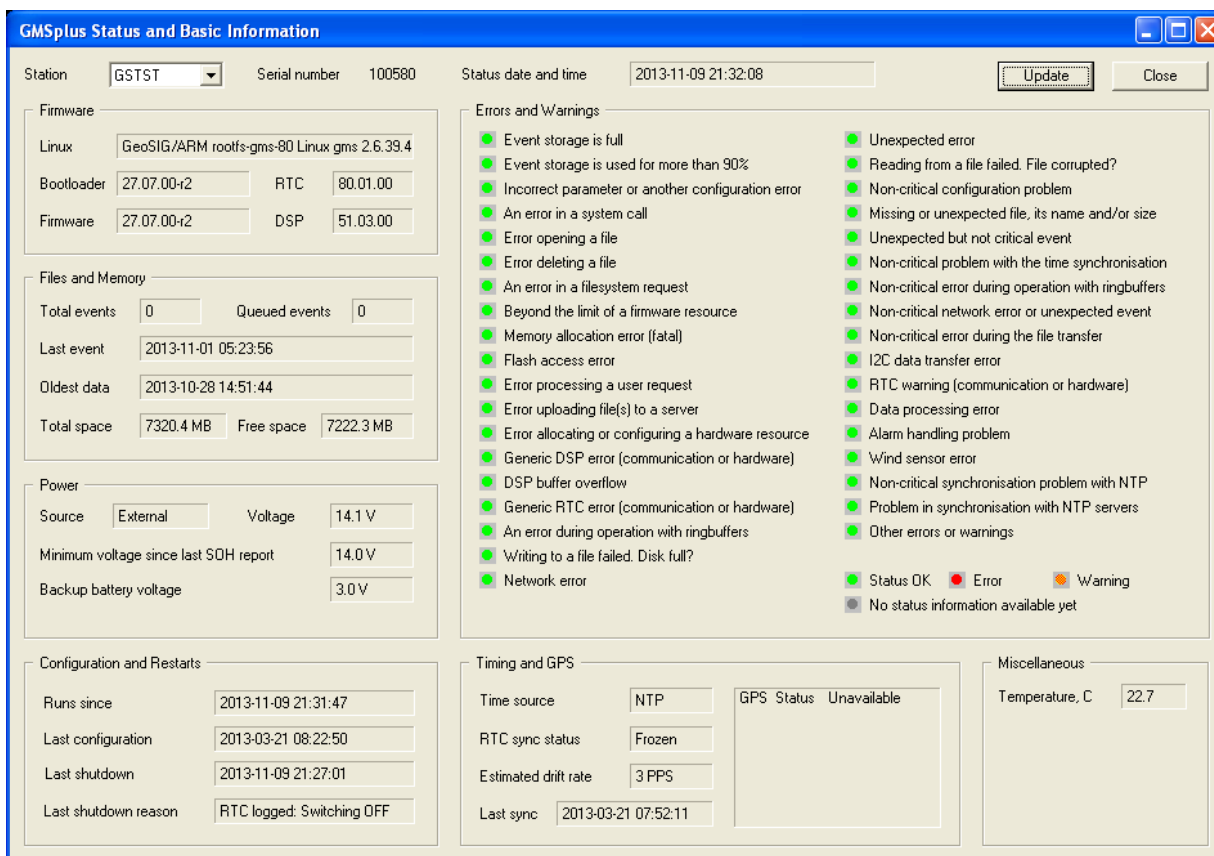

Figure 82: SOH information in GeoDAS

Information Area	Description
Status date and time	Before analysing the SOH data always make sure that the SOH files are current ones by checking the time and date here.
Firmware	Here the firmware versions of all components can be viewed.
File and Memory	Information about events and available memory
Configuration and Restarts	Date and time of the last restart, the last configuration change and the last shutdown are shown. Additionally the reason of the last shutdown is indicated.
Miscellaneous	Ambient temperature, measured inside the instrument. Other information may appear here, depending on the firmware version of the instrument.
Errors and Warnings	List of all errors and warnings of the instrument
Timing and GPS	Status of the RTC and the related GPS information if a GPS receiver is connected and configured
Power	Status of the power supply and the battery voltages

### C.3.2 Instrument Setup...

See chapter 9.2.2 for details.

### C.3.3 Cancel Pending Request

The pending requests on the server, as shown in the Figure 70, can be canceled by the user.

### C.3.4 Instrument Communication Interface

- Make a right click on the Station in the GeoDAS main window and select **Instrument Control...**; the following window will appear:

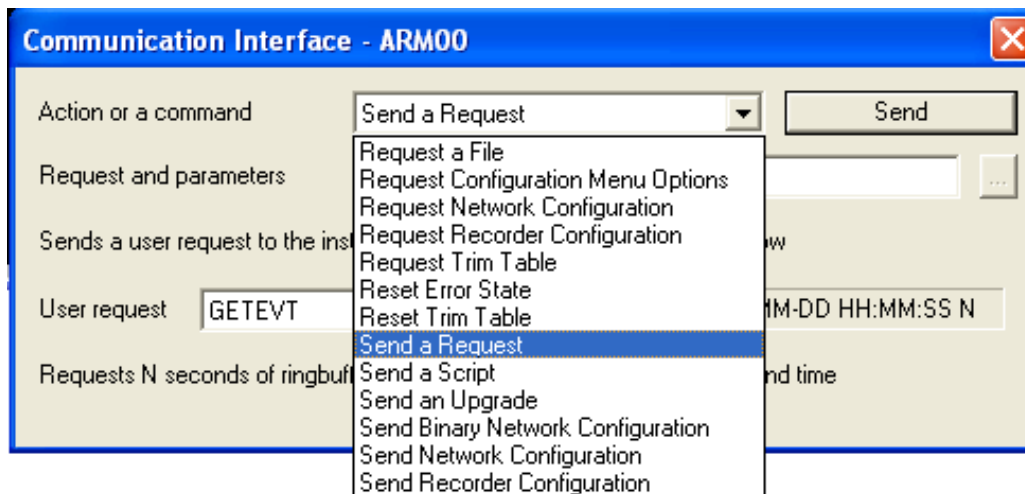

Figure 83: Instrument Communication Interface

Action or command	Description
Request a File	Request a file from the instrument (the full path to the file must be specified)
Request Configuration Menu Options	The instrument uploads the structure of the configuration menu and saves the file in <code>\\GeoDAS_DATA\Config\Stationname.mnu</code> . This file is needed for offline configuration of the instrument as described in chapter 9.2.1
Request Network Configuration	The instrument uploads the network settings of the instrument and saves the file in <code>\\GeoDAS_DATA\Config\Stationname.net</code>
Request Recorder Configuration	The instrument uploads the configuration of the instrument and saves the file in <code>\\GeoDAS_DATA\Config\Stationname.xml</code> . This file is needed for offline configuration of the instrument as described in chapter 9.2.1
Request Trim Table	The instrument will upload a SOH file containing the actual values from the RTC trim table. The latest SOH file can be found under <code>\\GeoDAS_DATA&gt;StatusFiles\InfoSOH.xml</code>
Reset Error State	The instrument will clear all errors and warnings.
Reset Trim Table	The instrument will clear the RTC trim table.
Send a Request	Sends a user request to the instrument. For details see chapter 9.12.1
Send a Script	The instrument will download and execute the attached script. This function is for advanced users only, as it can seriously damage the instrument if the script is not written correctly.
Send an Upgrade	The instrument will download the attached file, which can be any type of the firmware, namely: Bootloader, RTC, DSP, main firmware and or the entire Linux image. For more details about the upgrade of the firmware, see chapter 11.
Send Binary Network Configuration	The instrument will download binary network configuration file from the server.
Send Network Configuration	The instrument will download the attached manually adjusted network configuration file from the server.
Send Recorder Configuration	The instrument will download the attached manually adjusted recorder configuration from the server.

## C.4 Open recorded miniSEED files in GeoDAS

The system is recording miniSEED files (.MSD). For viewing such files, GeoDAS can be used. As the signal is stored inside the miniSEED file in counts, a scaling factor has to be applied when opening the data. If an **Extended format of MiniSEED** files is used (see the chapter 9.9), scaling factors are applied by GeoDAS automatically, and you may skip the information below.

- Open GeoDAS
- Open recorded mini-seed file from the menu **File** → **Open...**



Event files are stored under: `\\GeoDAS_DATA\Data\STATION_NAME`  
 Ringbuffer files are stored under: `\\GeoDAS_DATA\DataStreams\STATION_NAME`  
 Testpulses are stored under: `\\GeoDAS_DATA \Incoming\NNNNNN`

- When you open a '.MSD' file with *GeoDAS*, the following dialog box for scaling factor appears:

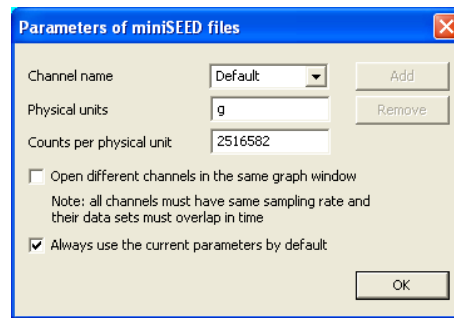

Figure 84: GeoDAS miniSEED parameters

- The values *Physical unit* and *Counts per physical unit* must be set for correct display data in GeoSIG software GeoDAS. The values can be calculated as described in chapter [C.4.2](#).



The user has the possibility to tick "Always use the current parameters" because the unit gets send with the miniseed file

- Press **OK**
- If instead of the scale prompt you get directly the graph, to get back the prompt each time you open a miniSEED file, use menu: *Analyse* → *Parameters...* → *Parameters of miniSEED files* and press **Edit**:

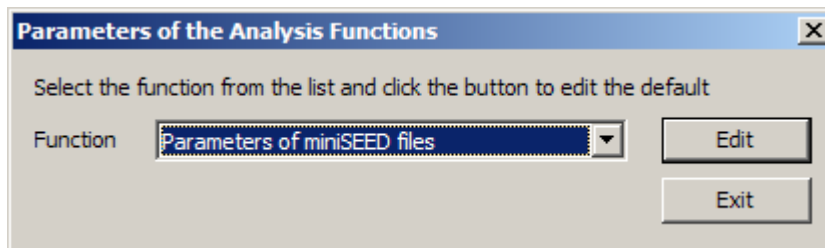

Figure 85: GeoDAS analysis parameters

- Now the dialog box for scaling factor should be seen. Enter the correct values, close and reopen the file you want to see. You will be prompted again for scale; just press OK as the scale is now correct.

### C.4.1 Save predefined Scaling Factors

The scaling factor set under Counts per physical unit is always valid for all channels in the same miniSEED file. If the channels have different physical units (e.g. if a six-channel instrument with two different types of sensors is used) a scaling factor for each channel separately can be defined.

To define a scaling factor for a specific channel, enter the full channel name (e.g. LCAX1) in the *filed Channel* name and press **Add**

All channels which are not specifically defined are converted with the scaling factor saved under *Default*.

#### **C.4.2 Calculation of the Scaling Factors**

The scaling factor is the inverse of the LSB value.

$$\textit{Scalingfactor} = \frac{1}{\textit{LSB}}$$

See section ?? for details about how to calculate the LSB factor.